



The better solution.

## PRODUCT CATALOGUE



WELLNESS  
2022/2023

**WDT**  
Werner Dosiertechnik





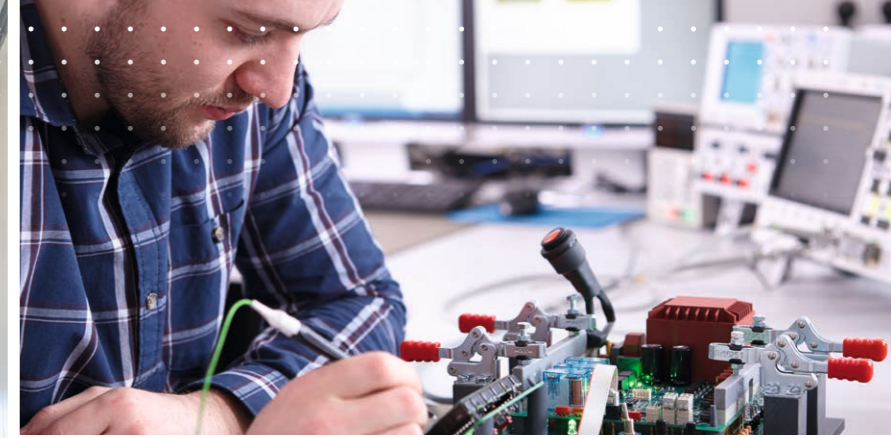

## 35 YEARS OF EXPERIENCE IN SWIMMING POOL AND WELLNESS TECHNIQUES

Mr. Dietmar Werner has founded our company 35 years ago with the invention of the GRANUDOS system for the dosing of chlorine granulate. Today we develop, produce and distribute an extensive and comprehensive product range of measuring, control and dosing systems for the disinfection of public and private swimming pools, as well as control and attraction systems for wellness facilities and dosing systems for drinking and wastewater treatment.

From our point of view it is a necessary core competence to understand the application areas of our products and its associated technical systems as a total, to be able to transfer this know-how to our partners.

We export 75 % of all of our products. Our team is the foundation of our success. Due to on-going professional development programmes and trainings, our 58 employees are always up-to-date with the latest developments.

### WDT Werner Dosierttechnik stands for:

- Comprehensive know-how
- Highest material and product quality
- Professional consulting
- Extensive service network of our trained partners
- Exclusively educated and qualified employees
- Service and solution orientation
- Continuous development

## DEVELOPMENT

### Our internal development includes:

- Conceptual development
- Constructive development
- Electronic hard- and software development

### Our developments are:

- The prerequisite for a common, successful future
- Customised, market driven solutions through the combination of your demands and our know-how and experiences
- The fundament for the best water quality and the well-being of guests in swimming pools and wellness oases



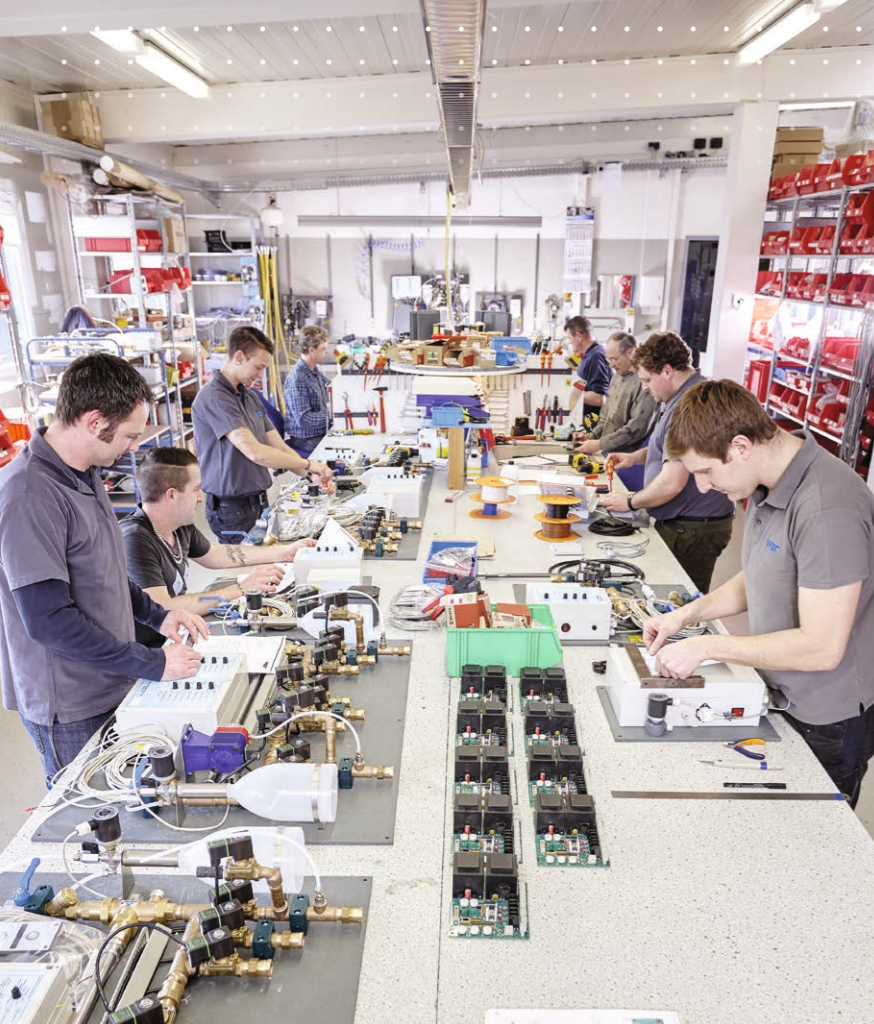

## PRODUCTION

Our high quality standard is the guarantee for the trust and satisfaction of our customers.

### WDT products offer:

- Highest functionality and quality level
- Sophisticated technology
- Exclusively components from German and European manufacturers
- Individually tested reliability

We produce all our products at our factories in Wertingen (headquarters) and in Ruppolding.

 **MADE IN GERMANY**  
since 1986

## SERVICE

Our whole team works with the fullest conviction, engagement and passion for you during all stages of our cooperation.

### WDT service supports:

- During planning, installation and maintenance
- Quick and reliable
- Professional and comprehensive
- Our cooperative partnership

## CERTIFICATION

We have been DIN ISO 9001 certified since 2008.

### Our quality management system is:

- The foundation for our sustainable product and service quality
- The guideline for our daily work
- The basis of the continuous improvement of our processes
- A fundamental part of our corporate- and error culture



## AWARDED

At the 24th of June 2022 we have been awarded with the TOP 100 seal for outstanding innovative power for the second time.

### Our company:

- Is continuously and consistently focused on innovation
- Convinced in the category "Innovative processes and organisation"





CONTENT



- 10** Experience Showers
- 14 Control panels / Packages
- 58** Shower Tunnels
- 64** Shower Vision
- 70** Components in detail
- 72 Push Button Plates
- 74 Nozzles
- 76 Ceiling Elements
- 80 Sound Module



- 82** Technique for Steam Rooms
- 84 Dosing of fragrances for steam rooms - DUFTDOS
- 89 Steam impact
- 90 LED illumination
- 96 Steam generators
- 98 Technique for Healing Clay Steam Bath
- 100 Accessories for steam rooms
- 102** Moduleconcept



- 106** Technique for Saunas
- 108 Dosing-system for an automatic sauna-splash - SAUNA-PLUS
- 110 LED illumination



- 114** Nebulisation of brine solution - SOLDOS
- 115 For steam rooms
- 116 For dry rooms



- 118** Foam for Hammam Massages - FOAMDOS



- 120** Foot bath sputtering system
- 122 Technique
- 124 Basins



- 128** Room aromatisation



- 132** Control and regulation systems for Wellness areas
- 134 Central control systems
- 135 Steam room controls



- 136** Fragrances, Brine solution, Foam agent



WELLNESS BY WDT

The better solution.

Relax, experience, regenerate. Due to this social trend, the number of wellness & spa centres in the private and public sector has increased enormously over the last years. As a result, technical equipment for wellness facilities has become a main pillar of WDT's business activities.

Our product range for control and dosing systems is a compilation of own ideas and ideas from all over the world, which have inspired us: Experience Showers, techniques for steam rooms, techniques for saunas, nebulisation of brine solution, aromatisation systems and control system for complete Wellness facilities. Innovations of WDT increase the attractiveness and the comfort of SPA centres and therefore the feel-well factor of the guests.





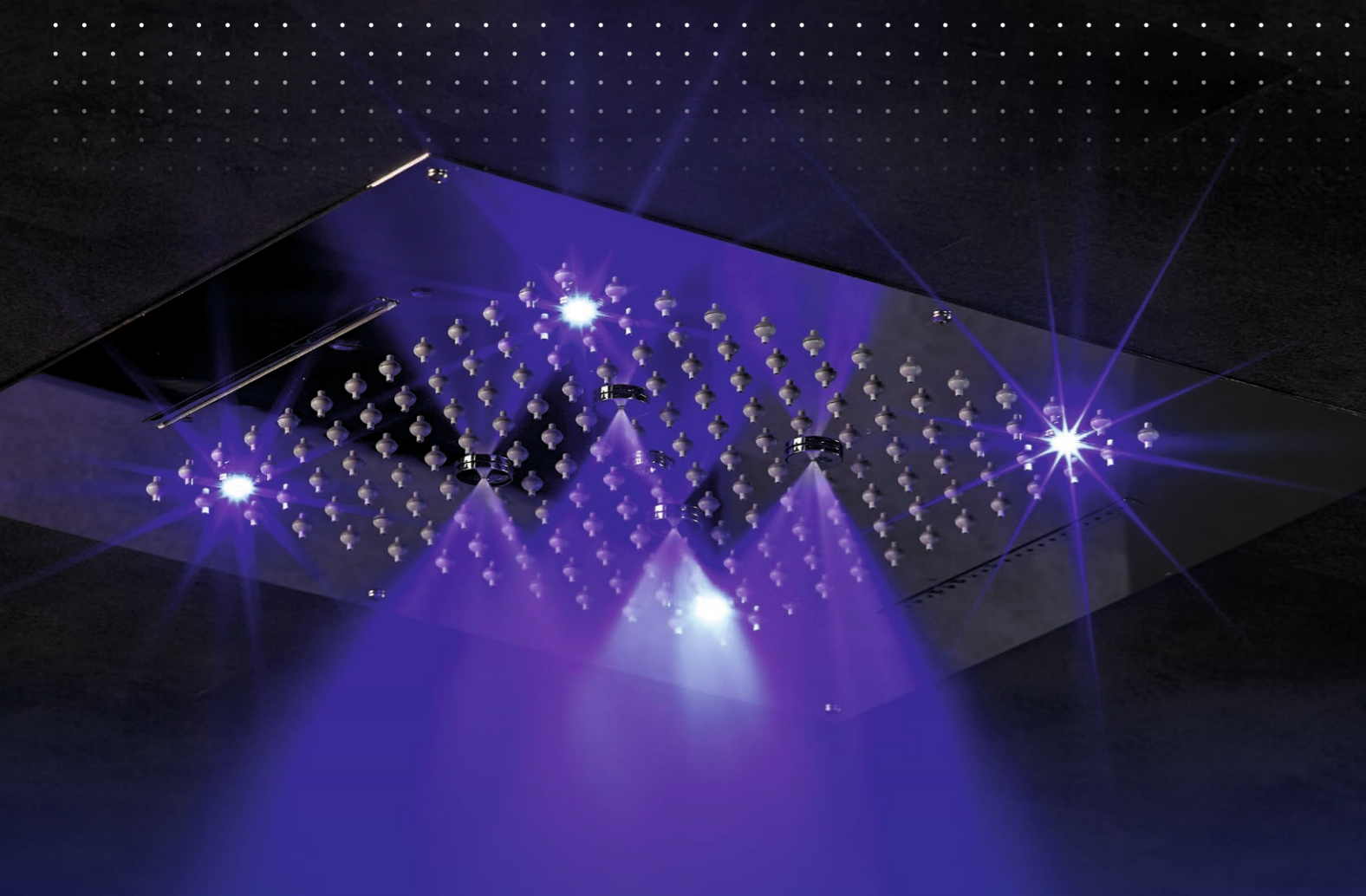

## EXPERIENCE SHOWERS

Smell, sight, hearing and touch: Experience Showers activate all the users' senses. Aromatised rain showers with light- and sound effects create the most pleasant dream worlds for the user.

By the push of a button, a warm tropical rain patters onto the shower guest. An exotic aroma fills the air. Birds tweet and a warm light shines. Flashing lights and growling thunder fill the room. This is only one of many possible shower scenarios that are realisable with our product line Experience Showers.

There are nearly no limits to the fantasy and the technical possibilities available.

- 14 Control panels / Packages
- 58 Shower Tunnels**
- 64 Shower Vision**
- 70 Components in detail**
- 72 Push Button Plates
- 74 Nozzles
- 76 Ceiling Elements
- 80 Sound Module

# ALL SENSES



## MULTISENSUAL

- » Experience Showers increase the attractiveness and the comfort of residential and public SPAs
- » Creation of unique dream worlds
- » Guaranteed feel-well factor for the user
- » Sustainable shower pleasure by controllable water consumption

### WATCH OUR EXPERIENCE SHOWER VIDEO.

Scan the QR code or search for "WDT experience showers" on youtube.







## THE TAILOR-MADE SOLUTION FOR EACH APPLICATION!

- High grade of flexibility due to a modular design
- Individual configuration possibilities due to the sectional product structure
- Plug and play systems
- Pre-mounted components (controller, thermomixer, solenoid valves, backflow preventer, aroma pump) guarantee an easy, quick and trouble-free installation

## PACKAGES / COMPONENTS

An Experience Shower consists generally of the following components, which can be combined very variable with each other. On the following pages, you find the descriptions of the components and proposals for pre-configured standard packages.

### CONTROL PANEL



### CEILING ELEMENT INCL. ILLUMINATION

Stainless steel chrome optic

PVC

Backlit

Corian®

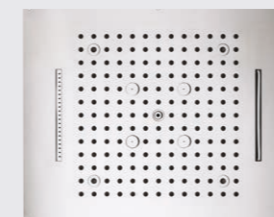

### PUSH BUTTON PLATE

Stainless steel polished

Stainless steel brushed

Alu-Dibond

Corian®



### SOUND MODULE

MP3-Player

Speaker

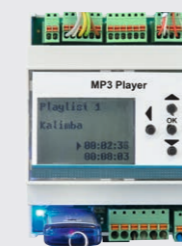





## FOG SHOWER W2 WITH CEILING ELEMENT PVC

### FUNCTION DESCRIPTION

After the start of the programme by a button, the light in the shower changes from white to blue. A cold, refreshing Fog with very fine droplets starts to spray and a minty, cooling aroma fills the air. In a distance you hear the sound of waves and sea. After the end of the programme, the illumination changes back to white, the Fog and the sound are switching off. The endurance of the programme and the aroma intensity can be adjusted individually at the controller. As an option, the tubing to the nozzles can be emptied automatically after the programme.

### SCOPE OF DELIVERY OF A COMPLETE PACKAGE

#### CONTROL PANEL



Control panel incl. listed parts, pre-tubed, pre-wired and pre-mounted on PP board grey - Part no. 13428:

- Supply with pre-filter and ball valve MS ½" female thread
- Outlet with solenoid valve ½" and screwing ½"
- Fragrance pump with fragrance reservoir and empty switch
- Dosing valve for the injection of aroma into the water tube
- Microprocessor controller EDS1 in housing

#### TECHNICAL DATA

Electrical supply	230 V-AC, 50 Hz
Power supply	100 W
Water supply	½" female thread
Dimensions (W/H/D)	500 x 650 x 200 mm
Weight	app. 10 kg

#### PUSH BUTTON

Details see page 72



- 1 x Push-button plate 1-fold Alu-Dibond - Part no. 19011
- 1 x Bonnet 1-fold - Part no. 21030-1
- 1 x Name plate "Cold Mist" - Part no. 19951

#### CEILING ELEMENT INCL. ILLUMINATION

Details see page 76



1 x Ceiling element PVC white Ø 800 x 19 mm with 3 LED Spots RGB Ø 48 incl. RGB controller SAU and 7 m cable with 2 connections for 2 nozzles - Part no. 21748-1

#### NOZZLES

Details see page 74

- 2 x Fog Nozzle ½" - Part no. 13526
- 2 x Cover Screen for Fog Nozzle - Part no. 13877

#### SOUND

Details see page 80



- 1 x Sound module MP3 - Part no. 18824-1
- 1 x Speaker - Part no. 14366-4

#### TO BE PROVIDED BY THE BUILDER

- Plants room for the installation of the control panel
- Power supply
- Water connection cold ½"
- Needed pressure: 3 bar dynamic
- Water quantity: app. 10 l/min at the use of 2 Fog Nozzles
- Tubing to the nozzles
- Non-return according to DIN EN 1717 in the supply
- Drain in the plants room

#### ACCESSORIES / OPTIONS

- Optionally you can use Corian® or backlit ceiling element instead of PVC
- Fragrance
- Emptying





## EVENT SHOWER W3 WITH SIDE NOZZLES

### FUNCTION DESCRIPTION

The Event Shower W3 is ideal for a Kneipp cooling effect from the legs in direction of the heart by side nozzles. After the start of the programme by a button, the light in the shower changes from white to blue. The lowest pair of side nozzles (level of the legs) starts to spray cold water.

### SCOPE OF DELIVERY OF A COMPLETE PACKAGE

#### CONTROL PANEL



Control panel incl. listed parts, pre-tubed, pre-wired and pre-mounted on PP board grey - Part no. 12376:

- Supply with pre-filter and ball valve MS 3/4" female thread
- 3 x Outlet with solenoid valve 1/2" and screwing 1/2"
- Microprocessor controller EDS1 in housing

#### TECHNICAL DATA

Electrical supply	230 V-AC, 50 Hz
Power supply	100 W
Water supply	3/4" female thread
Dimensions (W/H/D)	500 x 500 x 200 mm
Weight	app. 7 kg

After an adjustable time the middle pair of nozzles (level of the hips) follows and after the same time the upper pair of nozzles (level of the upper part of the body). The pairs of nozzles can work together or separately from each other. After the end of the programme, the illumination changes back to white and the nozzles are switching off.

#### PUSH BUTTON

Details see page 72



- 1 x Push-button plate 1-fold Alu-Dibond - Part no. 19011
- 1 x Bonnet 1-fold - Part no. 21030-1
- 1 x Name plate "Kneipp" - Part no. 17787

#### NOZZLES

Details see page 74

- 6 x Side Nozzle - Part no. 19769-2



#### ILLUMINATION

- 3 x LED Spots RGB - Part no. 21625
- 3 x Mounting sleeve for LED Spots - Part no. 20973
- 2 x 2,5 m Extension cable - Part no. 20748
- 1 x Controller for LED Spot - Part no. 24630
- 1 x Relais board NT34 for light - Part no. 24926

#### TO BE PROVIDED BY THE BUILDER

- Plants room for the installation of the control panel
- Power supply
- Water connection cold 3/4"
- Needed pressure: 3 bar dynamic
- Water quantity: app. 36 l/min at the use of 6 Side Nozzles
- Tubing to the nozzles

## EVENT SHOWER WK4 WITH SIDE NOZZLES

### FUNCTION DESCRIPTION

The Event Shower WK4 is ideal for a Kneipp hot-cold change shower from the legs in direction of the heart by side nozzles. After the start of the programme by a button, the light in the shower changes from white to blue. The lowest pair of side nozzles at the level of the legs starts to spray cold water.

### SCOPE OF DELIVERY OF A COMPLETE PACKAGE

#### CONTROL PANEL



Control panel incl. listed parts, pre-tubed, pre-wired and pre-mounted on PP board grey - Part no. 15589:

- 2 x Supply with pre-filter and ball valve MS 1/2" female thread
- Thermomixer JRG 1/2" with non-return valves
- 4 x Outlet with solenoid valve 1/2" and screwing 1/2"
- 2 x solenoid valve 1/2" for cold-warm change
- Microprocessor controller EDS1 in housing

#### TECHNICAL DATA

Electrical supply	230 V-AC, 50 Hz
Power supply	100 W
Water supply	2 x 1/2" female thread
Dimensions (W/H/D)	650 x 500 x 200 mm
Weight	app. 10 kg

After an adjustable time the pair of nozzles at the level of the hips follows, then the pair of nozzles at the level of the stomach followed by a pair at the level of the shoulders. Now the temperature changes from cold to warm water, the light changes to red and the 4 pairs of nozzles work in the opposite direction. After the end of the programme, the illumination changes back to white and the nozzles are switching off.

#### PUSH BUTTON

Details see page 72



- 1 x Push-button plate 1-fold Alu-Dibond - Part no. 19011
- 1 x Bonnet 1-fold - Part no. 21030-1
- 1 x Name plate "Kneipp" - Part no. 17787

#### NOZZLES

Details see page 74

- 8 x Side Nozzle - Part no. 19769-2



#### ILLUMINATION

- 3 x LED Spots RGB - Part no. 21625
- 3 x Mounting sleeve for LED Spots - Part no. 20973
- 2 x 2,5 m Extension cable - Part no. 20748
- 1 x Controller for LED Spot - Part no. 24630
- 1 x Relais board NT34 for light - Part no. 24926

#### TO BE PROVIDED BY THE BUILDER

- Plants room for the installation of the control panel
- Power supply
- Water connection cold 1/2"
- Water connection warm 1/2"
- Needed pressure: 3 bar dynamic
- Water quantity: app. 48 l/min at the use of 8 Side Nozzles
- Tubing to the nozzles





## NIAGARA RAIN SED1-2K WITH CEILING ELEMENT PVC

### FUNCTION DESCRIPTION

#### Programme 1: Tropical Rain

After the start of the programme by a button, the light in the shower changes from white to red. A warm Tropical Rain with big, smooth drops patters onto the guest in the shower. You hear birds tweeting. After the end of the programme, the illumination changes back to white, the Tropical Rain and the sound are switching off.

#### Programme 2: Fog Shower

After the start of the programme by a button, the light in the shower changes from white to blue. A cold, refreshing Fog with very fine droplets starts to spray. In a distance you hear the sound of waves and sea. After the end of the programme, the illumination changes back to white, the Fog and the sound are switching off.

#### Programme 3: Niagara Rain

The programme starts with the cold, refreshing Fog Shower and blue light. In a distance, you hear the sound of waves and sea. In the following, the warm Tropical Rain with big, smooth drops increases the water volume and works together with the cold Fog. The illumination in the shower changes to a red-green colour change. In the last step of the programme, the warm Tropical Rain stops and the programme finishes with the cold Fog and a blue-green colour change. After the end of the programme, the illumination changes back to white, the Fog and the sound are switching off.

### SCOPE OF DELIVERY OF A COMPLETE PACKAGE

#### CONTROL PANEL



Control panel incl. listed parts, pre-tubed, pre-wired and pre-mounted on PP board grey - Part no. 14128:

- 2 x Supply with pre-filter and ball valve MS 1/2" female thread
- Thermomixer JRG 1/2" with non-return valves
- 2 x Outlet with solenoid valve 1/2" and screwing 1/2"
- Microprocessor controller EDS1 in housing

#### TECHNICAL DATA

Electrical supply	230 V-AC, 50 Hz
Power supply	100 W
Water supply	2 x 1/2" female thread
Dimensions (W/H/D)	500 x 650 x 200 mm
Weight	app. 7 kg

#### PUSH BUTTON

Details see page 72



- 1 x Push-button plate 3-fold Alu-Dibond - Part no. 19013
- 1 x Bonnet 3-fold - Part no. 21031-1
- 1 x Name plate "Tropical Rain" - Part no. 17528
- 1 x Name plate "Cool Fog" - Part no. 17534
- 1 x Name plate "Niagara Rain" - Part No.. 23923

#### CEILING ELEMENT INCL. ILLUMINATION

Details see page 76



1 x Ceiling element PVC white Ø 800 x 19 mm with 3 LED Spots RGB Ø 48 incl. RGB controller SAU and 7 m cable with 4 connections for 4 nozzles - Part no. 21768-3

#### NOZZLES

Details see page 74

- 2 x Rain Nozzle 1/2" - Part no. 13528
- 2 x Cover Screen for Rain Nozzle - Part no. 13879
- 2 x Fog Nozzle 1/2" - Part no. 13526
- 2 x Cover Screen for Fog Nozzle - Part no. 13877

#### SOUND

Details see page 80



- 1 x Sound module MP3 - Part no. 18824-1
- 1 x Speaker - Part no. 14366-4

#### TO BE PROVIDED BY THE BUILDER

- Plants room for the installation of the control panel
- Power supply
- Water connection cold 1/2"
- Water connection warm 1/2"
- Needed pressure: 3 bar dynamic
- Water quantity: app. 60 l/min at the use of 2 Rain- and 2 Fog Nozzles
- Tubing to the nozzles

#### ACCESSORIES / OPTIONS

- Optionally you can use Corian® or backlit ceiling element instead of PVC





## NIAGARA RAIN SED1-2K WITH CEILING ELEMENT STAINLESS STEEL

### FUNCTION DESCRIPTION

#### Programme 1: Tropical Rain

After the start of the programme by a button, the light in the shower changes from white to red. A warm Tropical Rain with big, smooth drops patters onto the guest in the shower. You hear birds tweeting. After the end of the programme, the illumination changes back to white, the Tropical Rain and the sound are switching off.

#### Programme 2: Fog Shower

After the start of the programme by a button, the light in the shower changes from white to blue. A cold, refreshing Fog with very fine droplets starts to spray. In a distance you hear the sound of waves and sea. After the end of the programme, the illumination changes back to white, the Fog and the sound are switching off.

#### Programme 3: Niagara Rain

The programme starts with the cold, refreshing Fog Shower and blue light. In a distance, you hear the sound of waves and sea. In the following, the warm Tropical Rain with big, smooth drops increases the water volume and works together with the cold Fog. The illumination in the shower changes to a red-green colour change. In the last step of the programme, the warm Tropical Rain stops and the programme finishes with the cold Fog and a blue-green colour change. After the end of the programme, the illumination changes back to white, the Fog and the sound are switching off.

### SCOPE OF DELIVERY OF A COMPLETE PACKAGE

#### CONTROL PANEL



Control panel incl. listed parts, pre-tubed, pre-wired and pre-mounted on PP board grey - Part no. 14128:

- 2 x Supply with pre-filter and ball valve MS 1/2" female thread
- Thermomixer JRG 1/2" with non-return valves
- 2 x Outlet with solenoid valve 1/2" and screwing 1/2"
- Microprocessor controller EDS1 in housing

#### TECHNICAL DATA

Electrical supply	230 V-AC, 50 Hz
Power supply	100 W
Water supply	2 x 1/2" female thread
Dimensions (W/H/D)	500 x 650 x 200 mm
Weight	app. 7 kg

#### PUSH BUTTON

Details see page 72



- 1 x Push-button plate 3-fold stainless steel polished - Part no. 25940
- 1 x Bonnet 3-fold - Part no. 21031-1

#### CEILING ELEMENT INCL. ILLUMINATION

Details see page 76

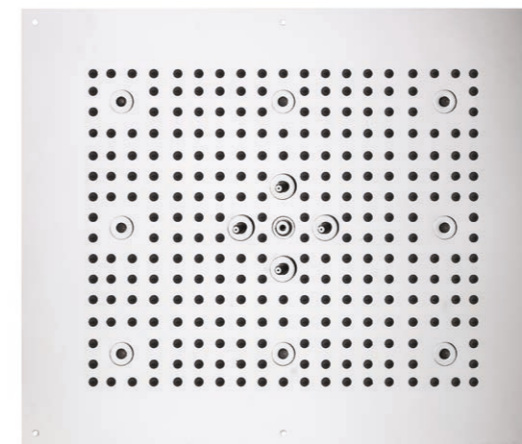

1 x Ceiling element stainless steel chrome optic (Rain Shower, Mist - 8 LED RGB Spots) - Part no. 24980

#### SOUND

Details see page 80



- 1 x Sound module MP3 - Part no. 18824-1
- 1 x Speaker - Part no. 14366-4

#### TO BE PROVIDED BY THE BUILDER

- Plants room for the installation of the control panel
- Power supply
- Water connection cold 1/2"
- Water connection warm 1/2"
- Needed pressure: 3 bar dynamic
- Water quantity: app. 40 l/min
- Tubing to the nozzles





## NIAGARA RAIN SED1-3K WITH CEILING ELEMENT PVC

### FUNCTION DESCRIPTION

#### Programme 1: Tropical Rain

After the start of the programme by a button, the light in the shower changes from white to red. A warm Tropical Rain with big, smooth drops patters onto the guest in the shower. In a distance you hear the sound of waves and sea. After the end of the programme, the illumination changes back to white, the Tropical Rain and the sound are switching off.

#### Programme 2: Spring Rain

After the start of the programme by a button, the light in the shower changes from white to green. A warm Drizzle Rain relaxes the guest in the shower. You hear birds tweeting. After the end of the programme, the illumination changes back to white, the Drizzle Rain and the sound are switching off.

#### Programme 3: Fog Shower

After the start of the programme by a button, the light in the shower changes from white to blue. A cold, refreshing Fog with very fine droplets starts to spray. You hear the burbling sound of an alpine creek. After the end of the programme, the illumination changes back to white, the Fog and the sound are switching off.

#### Programme 4: Niagara Rain

The programme starts with the warm Drizzle and green light. You hear birds tweeting. In the following the warm Tropical Rain with big, smooth drops increases the water volume and works together with the Drizzle. You hear a thunderstorm coming and you can see flashlights. In the final programme step the thunderstorm ends. The Tropical Rain stops and the cold Fog is spraying together with the warm Drizzle nozzles. The illumination in the shower changes to a blue-green colour change and you hear birds tweeting again. After the end of the programme the illumination changes back to white, the Fog, the Drizzle and the sound are switching off.

Optionally you can use Side- instead of Drizzle Nozzles for programme 2 and 4.

### SCOPE OF DELIVERY OF A COMPLETE PACKAGE

#### CONTROL PANEL



Control panel incl. listed parts, pre-tubed, pre-wired and pre-mounted on PP board grey - Part no. 14104:

- 2 x Supply with pre-filter and ball valve MS 3/4" female thread
- Thermomixer JRG 3/4" with non-return valves
- 2 x Outlet with solenoid valve 1/2" and screwing 1/2"
- 1 x Outlet with solenoid valve 3/4" and screwing 3/4"
- Microprocessor controller EDS1 in housing

#### TECHNICAL DATA

Electrical supply	230 V-AC, 50 Hz
Power supply	100 W
Water supply	2 x 3/4" female thread
Dimensions (W/H/D)	500 x 650 x 200 mm
Weight	app. 8 kg

#### PUSH BUTTON

Details see page 72



- 1 x Push-button plate 4-fold Alu-Dibond - Part no. 19014
- 1 x Bonnet 4-fold - Part no. 21032-1
- 1 x Name plate "Tropical Rain" - Part no. 17528
- 1 x Name plate "Spring Rain" - Part no. 17535
- 1 x Name plate "Cool Fog" - Part no. 17534
- 1 x Name plate "Niagara Rain" - Part No.. 23923

#### CEILING ELEMENT INCL. ILLUMINATION

Details see page 76



1 x Ceiling element PVC white Ø 800 x 19 mm with 3 LED Spots RGB Ø 48 incl. RGB controller SAU and 7 m cable with 6 connections for 6 nozzles - Part no. 21770-1

#### NOZZLES

Details see page 74

- 2 x Rain Nozzle 1/2" - Part no. 13528
- 2 x Cover Screen for Rain Nozzle - Part no. 13879
- 2 x Fog Nozzle 1/2" - Part no. 13526
- 2 x Cover Screen for Fog Nozzle - Part no. 13877
- 2 x Drizzle Nozzle 1/2" - Part no. 13527
- 2 x Cover Screen for Drizzle Nozzle - Part no. 13878

#### SOUND

Details see page 80



- 1 x Sound module MP3 - Part no. 18824-1
- 1 x Speaker - Part no. 14366-4

#### TO BE PROVIDED BY THE BUILDER

- Plants room for the installation of the control panel
- Power supply
- Water connection cold 3/4"
- Water connection warm 3/4"
- Needed pressure: 3 bar dynamic
- Water quantity: app. 60 l/min at the use of 2 Rain, 2 Fog- and 2 Drizzle Nozzles
- Tubing to the nozzles

#### ACCESSORIES / OPTIONS

- Optionally you can use Corian® or backlit ceiling element instead of PVC





## NIAGARA RAIN SED1-3K WITH CEILING ELEMENT STAINLESS STEEL

### FUNCTION DESCRIPTION

#### Programme 1: Tropical Rain

After the start of the programme by a button, the light in the shower changes from white to red. A warm Tropical Rain with big, smooth drops patters onto the guest in the shower. In a distance you hear the sound of waves and sea. After the end of the programme, the illumination changes back to white, the Tropical Rain and the sound are switching off.

#### Programme 2: Waterfall

After the start of the programme by a button, the light in the shower changes from white to green. Warm Waterfalls patter onto the guest in the shower. You hear birds tweeting. After the end of the programme, the illumination changes back to white, the Waterfalls and the sound are switching off.

#### Programme 3: Fog Shower

After the start of the programme by a button, the light in the shower changes from white to blue. A cold, refreshing Fog with very fine droplets starts to spray. You hear the burbling sound of an alpine creek. After the end of the programme, the illumination changes back to white, the Fog and the sound are switching off.

#### Programme 4: Niagara Rain

The programme starts with the warm Waterfalls and green light. You hear birds tweeting. In the following the warm Tropical Rain with big, smooth drops increases the water volume and works together with the Waterfalls. You hear a thunderstorm coming and you can see flashlights. In the final programme step the thunderstorm ends. The Tropical Rain stops and the cold Fog is spraying together with the warm Waterfalls. The illumination in the shower changes to a blue-green colour change and you hear birds tweeting again. After the end of the programme the illumination changes back to white, the Fog, the Waterfalls and the sound are switching off.

Optionally you can use Side- instead of Waterfall Nozzles for programme 2 and 4.

### SCOPE OF DELIVERY OF A COMPLETE PACKAGE

#### CONTROL PANEL

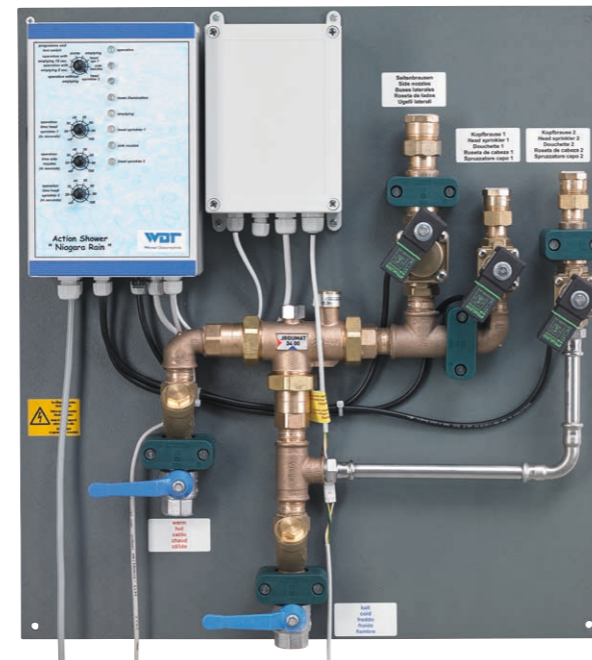

Control panel incl. listed parts, pre-tubed, pre-wired and pre-mounted on PP board grey - Part no. 14104:

- 2 x Supply with pre-filter and ball valve MS 3/4" female thread
- Thermomixer JRG 3/4" with non-return valves
- 2 x Outlet with solenoid valve 1/2" and screwing 1/2"
- 1 x Outlet with solenoid valve 3/4" and screwing 3/4"
- Microprocessor controller EDS1 in housing

#### TECHNICAL DATA

Electrical supply	230 V-AC, 50 Hz
Power supply	100 W
Water supply	2 x 3/4" female thread
Dimensions (W/H/D)	500 x 650 x 200 mm
Weight	app. 8 kg

#### PUSH BUTTON

Details see page 72



- 1 x Push-button plate 4-fold stainless steel polished - Part no. 25941
- 1 x Bonnet 4-fold - Part no. 21032-1

#### CEILING ELEMENT INCL. ILLUMINATION

Details see page 76

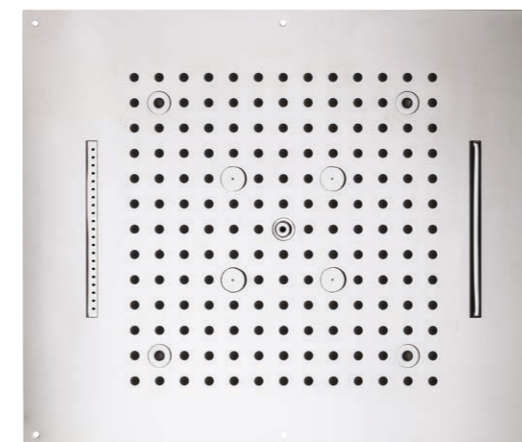

1 x Ceiling element stainless steel chrome optic (Rain Shower, Waterfall Full Blade, Waterfall Part Blade, Mist - 4 LED RGB Spots) - Part no. 24651

#### SOUND

Details see page 80



- 1 x Sound module MP3 - Part no. 18824-1
- 1 x Speaker - Part no. 14366-4

#### TO BE PROVIDED BY THE BUILDER

- Plants room for the installation of the control panel
- Power supply
- Water connection cold 3/4"
- Water connection warm 3/4"
- Needed pressure: 3 bar dynamic
- Water quantity: app. 70 l/min
- Tubing to the nozzles





## CARIBBEAN STORM SED2 WITH CEILING ELEMENT PVC

### FUNCTION DESCRIPTION

#### Programme 1: Tropical Rain with aroma

After the start of the programme by a button, the light in the shower changes from white to red. A warm Tropical Rain with big, smooth drops patters onto the guest in the shower. A fruity, lively aroma fills the air. In a distance you hear the sound of waves and sea. After the end of the programme, the illumination changes back to white, the Tropical Rain and the sound are switching off.

#### Programme 2: Spring Rain

After the start of the programme by a button, the light in the shower changes from white to green. A warm Drizzle Rain relaxes the guest in the shower. You hear birds tweeting. After the end of the programme, the illumination changes back to white, the Drizzle Rain and the sound are switching off.

#### Programme 3: Fog Shower

After the start of the programme by a button, the light in the shower changes from white to blue. A cold, refreshing Fog with very fine droplets starts to spray. You hear the burbling sound of an alpine creek. After the end of the programme, the illumination changes back to white, the Fog and the sound are switching off.

#### Programme 4: Caribbean Storm

The programme starts with the warm Drizzle and green light. You hear birds tweeting. In the following the warm Tropical Rain with big, smooth drops increases the water volume and works together with the Drizzle. A fruity, lively aroma fills the air. You hear a thunderstorm coming and you can see flashlights. In the final programme step the thunderstorm ends. The Tropical Rain stops and the cold Fog is spraying together with the warm Drizzle nozzles. The illumination in the shower changes to a blue-green colour change and you hear birds tweeting again. After the end of the programme the illumination changes back to white, the Fog, the Drizzle and the sound are switching off.

Optionally you can use Side- instead of Drizzle Nozzles for programme 2 and 4.

### SCOPE OF DELIVERY OF A COMPLETE PACKAGE

#### CONTROL PANEL



Control panel incl. listed parts, pre-tubed, pre-wired and pre-mounted on PP board grey - Part no. 14105:

- 2 x Supply with pre-filter and ball valve MS 3/4" female thread
- Thermomixer JRG 3/4" with non-return valves
- 2 x Outlet with solenoid valve 1/2" and screwing 1/2"
- 1 x Outlet with solenoid valve 3/4" and screwing 3/4"
- Emptying for the tube to the aromatised nozzle
- Fragrance pump with fragrance reservoir and empty switch
- Dosing valve for the injection of aroma into the water tube
- Non-return according to DIN EN1717
- Microprocessor controller EDS1 in housing

#### TECHNICAL DATA

Electrical supply	230 V-AC, 50 Hz
Power supply	100 W
Water supply	2 x 3/4" female thread
Dimensions (W/H/D)	750 x 750 x 200 mm
Weight	app. 15 kg

#### PUSH BUTTON

Details see page 72



- 1 x Push-button plate 4-fold Alu-Dibond - Part no. 19014
- 1 x Bonnet 4-fold - Part no. 21032-1
- 1 x Name plate "Tropical Rain" - Part no. 17528
- 1 x Name plate "Spring Rain" - Part no. 17535
- 1 x Name plate "Cool Fog" - Part no. 17534
- 1 x Name plate "Caribbean Storm" - Part No. 17527

#### CEILING ELEMENT INCL. ILLUMINATION

Details see page 76



1 x Ceiling element PVC white Ø 800 x 19 mm with 3 LED Spots RGB Ø 48 incl. RGB controller SAU and 7 m cable with 6 connections for 6 nozzles - Part no. 21770-1

#### NOZZLES

Details see page 74

- 2 x Rain Nozzle 1/2" - Part no. 13528
- 2 x Cover Screen for Rain Nozzle - Part no. 13879
- 2 x Fog Nozzle 1/2" - Part no. 13526
- 2 x Cover Screen for Fog Nozzle - Part no. 13877
- 2 x Drizzle Nozzle 1/2" - Part no. 13527
- 2 x Cover Screen for Drizzle Nozzle - Part no. 13878

#### SOUND

Details see page 80



- 1 x Sound module MP3 - Part no. 18824-1
- 1 x Speaker - Part no. 14366-4

#### TO BE PROVIDED BY THE BUILDER

- Plants room for the installation of the control panel
- Power supply
- Water connection cold 3/4"
- Water connection warm 3/4"
- Needed pressure: 3 bar dynamic
- Water quantity: app. 60 l/min at the use of 2 Rain, 2 Fog- and 2 Drizzle Nozzles
- Drain in the plants room
- Tubing to the nozzles

#### ACCESSORIES / OPTIONS

- Optionally you can use Corian® or backlit ceiling element instead of PVC
- Fragrance





## CARIBBEAN STORM SED2 WITH CEILING ELEMENT STAINLESS STEEL

### FUNCTION DESCRIPTION

#### Programme 1: Tropical Rain with aroma

After the start of the programme by a button, the light in the shower changes from white to red. A warm Tropical Rain with big, smooth drops patters onto the guest in the shower. A fruity, lively aroma fills the air. In a distance you hear the sound of waves and sea. After the end of the programme, the illumination changes back to white, the Tropical Rain and the sound are switching off.

#### Programme 2: Waterfall

After the start of the programme by a button, the light in the shower changes from white to green. Warm Waterfalls patter onto the guest in the shower. You hear birds tweeting. After the end of the programme, the illumination changes back to white, the Waterfalls and the sound are switching off.

#### Programme 3: Fog Shower

After the start of the programme by a button, the light in the shower changes from white to blue. A cold, refreshing Fog with very fine droplets starts to spray. You hear the burbling sound of an alpine creek. After the end of the programme, the illumination changes back to white, the Fog and the sound are switching off.

#### Programme 4: Caribbean Storm

The programme starts with the warm Waterfalls and green light. You hear birds tweeting. In the following the warm Tropical Rain with big, smooth drops increases the water volume and works together with the Waterfalls. A fruity, lively aroma fills the air. You hear a thunderstorm coming and you can see flashlights. In the final programme step the thunderstorm ends. The Tropical Rain stops and the cold Fog is spraying together with the warm Waterfalls. The illumination in the shower changes to a blue-green colour change and you hear birds tweeting again. After the end of the programme the illumination changes back to white, the Fog, the Waterfalls and the sound are switching off.

Optionally you can use Side- instead of Waterfall Nozzles for programme 2 and 4.

### SCOPE OF DELIVERY OF A COMPLETE PACKAGE

#### CONTROL PANEL



Control panel incl. listed parts, pre-tubed, pre-wired and pre-mounted on PP board grey - Part no. 14105:

- 2 x Supply with pre-filter and ball valve MS 3/4" female thread
- Thermomixer JRG 3/4" with non-return valves
- 2 x Outlet with solenoid valve 1/2" and screwing 1/2"
- 1 x Outlet with solenoid valve 3/4" and screwing 3/4"
- Emptying for the tube to the aromatised nozzle
- Fragrance pump with fragrance reservoir and empty switch
- Dosing valve for the injection of aroma into the water tube
- Non-return according to DIN EN 1717
- Microprocessor controller EDS1 in housing

#### TECHNICAL DATA

Electrical supply	230 V-AC, 50 Hz
Power supply	100 W
Water supply	2 x 3/4" female thread
Dimensions (W/H/D)	750 x 750 x 200 mm
Weight	app. 15 kg

#### PUSH BUTTON

Details see page 72



- 1 x Push-button plate 4-fold stainless steel polished - Part no. 25941
- 1 x Bonnet 4-fold - Part no. 21032-1

#### CEILING ELEMENT INCL. ILLUMINATION

Details see page 76

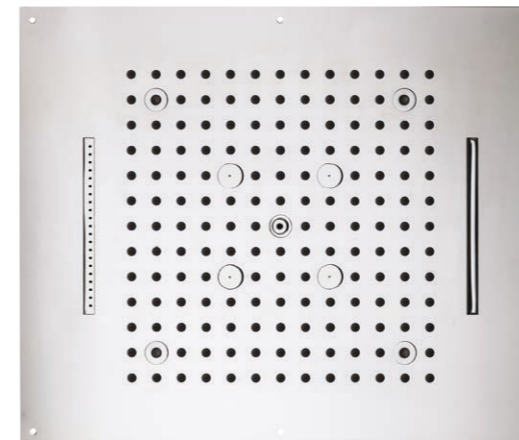

1 x Ceiling element stainless steel chrome optic (Rain Shower, Waterfall Full Blade, Waterfall Part Blade, Mist - 4 LED RGB Spots) - Part no. 24651

#### SOUND

Details see page 80



- 1 x Sound module MP3 - Part no. 18824-1
- 1 x Speaker - Part no. 14366-4

#### TO BE PROVIDED BY THE BUILDER

- Plants room for the installation of the control panel
- Power supply
- Water connection cold 3/4"
- Water connection warm 3/4"
- Needed pressure: 3 bar dynamic
- Water quantity: app. 70 l/min
- Drain in the plants room
- Tubing to the nozzles

#### ACCESSORIES / OPTIONS

- Fragrance





## MIDNIGHT RAIN SED3 WITH CEILING ELEMENT PVC

### FUNCTION DESCRIPTION

#### Programme 1: Fog Shower with aroma

After the start of the programme by a button, the light in the shower changes from white to blue. A cold, refreshing Fog with very fine droplets starts to spray and a minty, cooling aroma fills the air. You hear the burbling sound of an alpine creek. After the end of the programme, the illumination changes back to white, the Fog and the sound are switching off.

#### Programme 2: Spring Rain

After the start of the programme by a button, the light in the shower changes from white to red. A warm Drizzle Rain relaxes the guest in the shower. You hear birds tweeting. After the end of the programme, the illumination changes back to white, the Drizzle Rain and the sound are switching off.

#### Programme 3: Tropical Rain

After the start of the programme by a button, the light in the shower changes from white to green. A warm Tropical Rain with big, smooth drops patters onto the guest in the shower. In a distance you hear the sound of waves and sea. After the end of the programme, the illumination changes back to white, the Tropical Rain and the sound are switching off.

#### Programme 4: Midnight Rain

The programme starts with the warm Drizzle and red light. You hear birds tweeting. In the following the cold, refreshing Fog with very fine droplets works together with the Drizzle Rain. A minty, cooling aroma fills the air. You hear a thunderstorm coming and you can see flashlights. In the final programme step the thunderstorm ends. The cold Fog stops and the Tropical Rain is working together with the warm Drizzle nozzles. The illumination in the shower changes to red and you hear birds tweeting again. After the end of the programme the illumination changes back to white, the Tropical Rain, the Drizzle Rain and the sound are switching off.

Optionally you can use Side- instead of Drizzle Nozzles for programme 2 and 4.

### SCOPE OF DELIVERY OF A COMPLETE PACKAGE

#### CONTROL PANEL

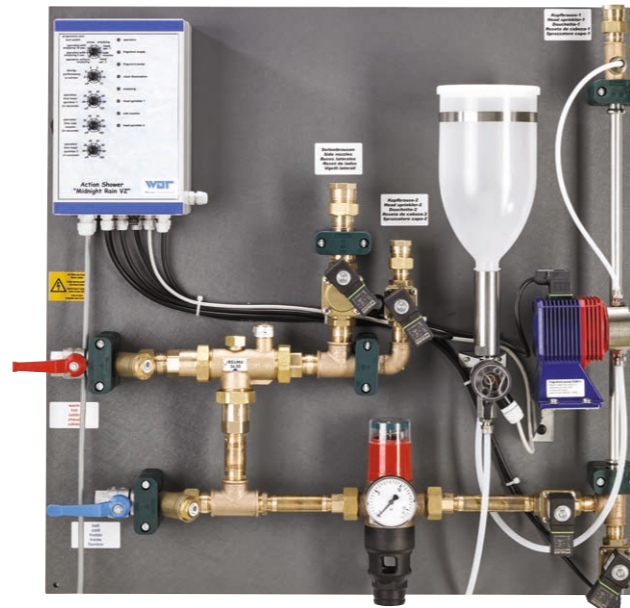

Control panel incl. listed parts, pre-tubed, pre-wired and pre-mounted on PP board grey - Part no. 14120:

- 2 x Supply with pre-filter and ball valve MS 3/4" female thread
- Thermomixer JRG 3/4" with non-return valves
- 2 x Outlet with solenoid valve 1/2" and screwing 1/2"
- 1 x Outlet with solenoid valve 3/4" and screwing 3/4"
- Emptying for the tube to the aromatised nozzle
- Fragrance pump with fragrance reservoir and empty switch
- Dosing valve for the injection of aroma into the water tube
- Non-return according to DIN EN 1717
- Microprocessor controller EDS1 in housing

#### TECHNICAL DATA

Electrical supply	230 V-AC, 50 Hz
Power supply	100 W
Water supply	2 x 3/4" female thread
Dimensions (W/H/D)	750 x 750 x 200 mm
Weight	app. 15 kg

#### PUSH BUTTON

Details see page 72



- 1 x Push-button plate 4-fold Alu-Dibond - Part no. 19014
- 1 x Bonnet 4-fold - Part no. 21032-1
- 1 x Name plate "Cool Fog" - Part no. 17534
- 1 x Name plate "Spring Rain" - Part no. 17535
- 1 x Name plate "Tropical Rain" - Part no. 17528
- 1 x Name plate "Midnight Rain" - Part No. 23101

#### CEILING ELEMENT INCL. ILLUMINATION

Details see page 76



1 x Ceiling element PVC white Ø 800 x 19 mm with 3 LED Spots RGB Ø 48 incl. RGB controller SAU and 7 m cable with 6 connections for 6 nozzles - Part no. 21770-1

#### NOZZLES

Details see page 74

- 2 x Rain Nozzle 1/2" - Part no. 13528
- 2 x Cover Screen for Rain Nozzle - Part no. 13879
- 2 x Fog Nozzle 1/2" - Part no. 13526
- 2 x Cover Screen for Fog Nozzle - Part no. 13877
- 2 x Drizzle Nozzle 1/2" - Part no. 13527
- 2 x Cover Screen for Drizzle Nozzle - Part no. 13878

#### SOUND

Details see page 80



- 1 x Sound module MP3 - Part no. 18824-1
- 1 x Speaker - Part no. 14366-4

#### TO BE PROVIDED BY THE BUILDER

- Plants room for the installation of the control panel
- Power supply
- Water connection cold 3/4"
- Water connection warm 3/4"
- Needed pressure: 3 bar dynamic
- Water quantity: app. 60 l/min at the use of 2 Rain, 2 Fog- and 2 Drizzle Nozzles
- Drain in the plants room
- Tubing to the nozzles

#### ACCESSORIES / OPTIONS

- Optionally you can use Corian® or backlit ceiling element instead of PVC
- Fragrance





## MIDNIGHT RAIN SED3 WITH CEILING ELEMENT STAINLESS STEEL

### FUNCTION DESCRIPTION

#### Programme 1: Fog Shower with aroma

After the start of the programme by a button, the light in the shower changes from white to blue. A cold, refreshing Fog with very fine droplets starts to spray and a minty, cooling aroma fills the air. You hear the burbling sound of an alpine creek. After the end of the programme, the illumination changes back to white, the Fog and the sound are switching off.

#### Programme 2: Waterfall

After the start of the programme by a button, the light in the shower changes from white to red. Warm Waterfalls patter onto the guest in the shower. You hear birds tweeting. After the end of the programme, the illumination changes back to white, the Waterfalls and the sound are switching off.

#### Programme 3: Tropical Rain

After the start of the programme by a button, the light in the shower changes from white to green. A warm Tropical Rain with big, smooth drops patters onto the guest in the shower. In a distance you hear the sound of waves and sea. After the end of the programme, the illumination changes back to white, the Tropical Rain and the sound are switching off.

#### Programme 4: Midnight Rain

The programme starts with the warm Waterfalls and red light. You hear birds tweeting. In the following the cold, refreshing Fog with very fine droplets works together with the Waterfalls. A minty, cooling aroma fills the air. You hear a thunderstorm coming and you can see flashlights. In the final programme step the thunderstorm ends. The cold Fog stops and the Tropical Rain is working together with the warm Waterfalls. The illumination in the shower changes to red and you hear birds tweeting again. After the end of the programme the illumination changes back to white, the Tropical Rain, the Waterfalls and the sound are switching off.

Optionally you can use Side- instead of Waterfall Nozzles for programme 2 and 4.

### SCOPE OF DELIVERY OF A COMPLETE PACKAGE

#### CONTROL PANEL

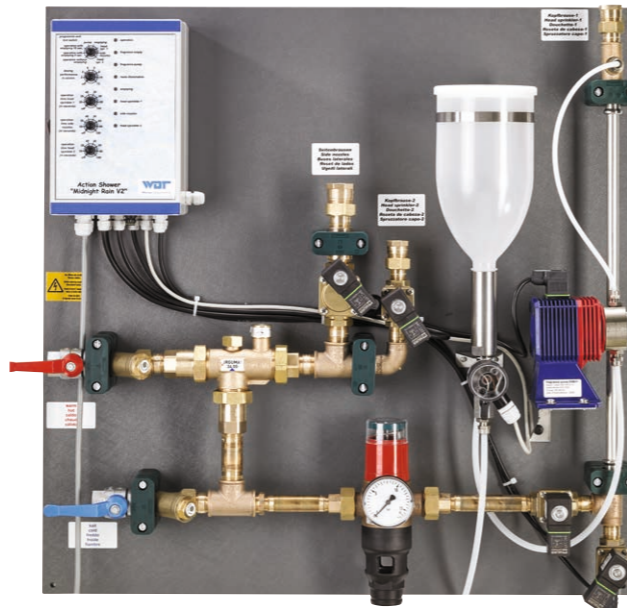

Control panel incl. listed parts, pre-tubed, pre-wired and pre-mounted on PP board grey - Part no. 14120:

- 2 x Supply with pre-filter and ball valve MS 3/4" female thread
- Thermomixer JRG 3/4" with non-return valves
- 2 x Outlet with solenoid valve 1/2" and screwing 1/2"
- 1 x Outlet with solenoid valve 3/4" and screwing 3/4"
- Emptying for the tube to the aromatised nozzle
- Fragrance pump with fragrance reservoir and empty switch
- Dosing valve for the injection of aroma into the water tube
- Non-return according to DIN EN 1717
- Microprocessor controller EDS1 in housing

#### TECHNICAL DATA

Electrical supply	230 V-AC, 50 Hz
Power supply	100 W
Water supply	2 x 3/4" female thread
Dimensions (W/H/D)	750 x 750 x 200 mm
Weight	app. 15 kg

#### PUSH BUTTON

Details see page 72



- 1 x Push-button plate 4-fold stainless steel polished - Part no. 25941
- 1 x Bonnet 4-fold - Part no. 21032-1

#### CEILING ELEMENT INCL. ILLUMINATION

Details see page 76

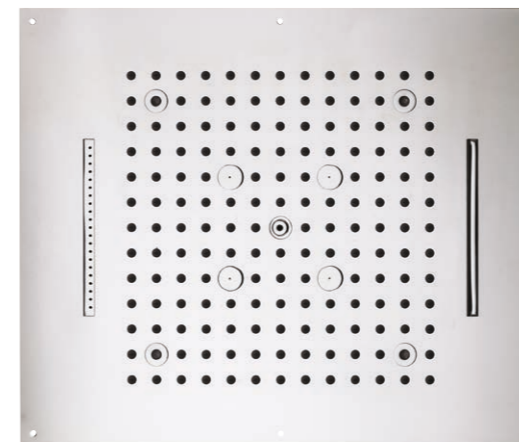

1 x Ceiling element stainless steel chrome optic (Rain Shower, Waterfall Full Blade, Waterfall Part Blade, Mist - 4 LED RGB Spots) - Part no. 24651

#### SOUND

Details see page 80



- 1 x Sound module MP3 - Part no. 18824-1
- 1 x Speaker - Part no. 14366-4

#### TO BE PROVIDED BY THE BUILDER

Plants room for the installation of the control panel

- Power supply
- Water connection cold 3/4"
- Water connection warm 3/4"
- Needed pressure: 3 bar dynamic
- Water quantity: app. 70 l/min
- Drain in the plants room
- Tubing to the nozzles

#### ACCESSORIES / OPTIONS

- Fragrance





## SIBERIAN NIGHT SED4 WITH CEILING ELEMENT PVC

### FUNCTION DESCRIPTION

#### Programme 1: Fog Shower with aroma

After the start of the programme by a button, the light in the shower changes from white to blue. A cold, refreshing Fog with very fine droplets starts to spray and a minty, cooling aroma fills the air. You hear the burbling sound of an alpine creek. After the end of the programme, the illumination changes back to white, the Fog and the sound are switching off.

#### Programme 2: Tropical Rain

After the start of the programme by a button, the light in the shower changes from white to red. A warm Tropical Rain with big, smooth drops patters onto the guest in the shower. You hear birds tweeting. After the end of the programme, the illumination changes back to white, the Rain and the sound are switching off.

#### Programme 3: Side Nozzles

After the start of the programme by a button, the light in the shower changes from white to green. Cold Side Nozzles massage the guest in the shower. In a distance you hear the sound of waves and sea. After the end of the programme, the illumination changes back to white, the Side Nozzles and the sound are switching off.

#### Programme 4: Siberian Night

The programme starts with a warm Tropical Rain and red light. You hear birds tweeting. In the following the cold, refreshing Fog with very fine droplets works together with the Tropical Rain. A minty, cooling aroma fills the air. The illumination changes to a red-green colour change. In the final programme step you hear a thunderstorm coming and you can see flashlights. The warm Tropical Rain is working together with the cold Side Nozzles. After the end of the programme the illumination changes back to white, the Tropical Rain, the Side Nozzles and the sound are switching off.

Optionally you can use Drizzle- instead of Side Nozzles for programme 2 and 4.

### SCOPE OF DELIVERY OF A COMPLETE PACKAGE

#### CONTROL PANEL



Control panel incl. listed parts, pre-tubed, pre-wired and pre-mounted on PP board grey - Part no. 14121:

- 1 x Supply cold with pre-filter and ball valve MS 3/4" female thread
- 1 x Supply warm with pre-filter and ball valve MS 1/2" female thread
- Thermomixer JRG 1/2" with non-return valves
- 2 x Outlet with solenoid valve 1/2" and screwing 1/2"
- 1 x Outlet with solenoid valve 3/4" and screwing 3/4"
- Emptying for the tube to the aromatised nozzle
- Fragrance pump with fragrance reservoir and empty switch
- Dosing valve for the injection of aroma into the water tube
- Non-return according to DIN EN 1717
- Microprocessor controller EDS1 in housing

#### TECHNICAL DATA

Electrical supply	230 V-AC, 50 Hz
Power supply	100 W
Water supply	1 x 3/4" female thread and 1 x 1/2" female thread
Dimensions (W/H/D)	750 x 750 x 200 mm
Weight	app. 15 kg

#### PUSH BUTTON

Details see page 72



- 1 x Push-button plate 4-fold Alu-Dibond - Part no. 19014
- 1 x Bonnet 4-fold - Part no. 21032-1
- 1 x Name plate "Cool Fog" - Part no. 17534
- 1 x Name plate "Tropical Rain" - Part no. 17528
- 1 x Name plate "Side Nozzles" - Part no. 18986
- 1 x Name plate "Siberian Night" - Part No. 18764

#### CEILING ELEMENT INCL. ILLUMINATION

Details see page 76



1 x Ceiling element PVC white Ø 800 x 19 mm with 3 LED Spots RGB Ø 48 incl. RGB controller SAU and 7 m cable with 4 connections for 4 nozzles - Part no. 21768-3

#### NOZZLES

Details see page 74

- 2 x Rain Nozzle 1/2" - Part no. 13528
- 2 x Cover Screen for Rain Nozzle - Part no. 13879
- 2 x Fog Nozzle 1/2" - Part no. 13526
- 2 x Cover Screen for Fog Nozzle - Part no. 13877
- 6 x Side Nozzle - Part no. 19769-2



#### SOUND

Details see page 80



- 1 x Sound module MP3 - Part no. 18824-1
- 1 x Speaker - Part no. 14366-4

#### TO BE PROVIDED BY THE BUILDER

- Plants room for the installation of the control panel
- Power supply
- Water connection cold 3/4"
- Water connection warm 1/2"
- Needed pressure: 3 bar dynamic
- Water quantity: app. 70 l/min at the use of 2 Rain, 2 Fog- and 6 Side Nozzles
- Drain in the plants room
- Tubing to the nozzles

#### ACCESSORIES / OPTIONS

- Optionally you can use Corian® or backlit ceiling element instead of PVC
- Fragrance





## SIBERIAN NIGHT SED4 WITH CEILING ELEMENT STAINLESS STEEL

### FUNCTION DESCRIPTION

#### Programme 1: Fog Shower with aroma

After the start of the programme by a button, the light in the shower changes from white to blue. A cold, refreshing Fog with very fine droplets starts to spray and a minty, cooling aroma fills the air. You hear the burbling sound of an alpine creek. After the end of the programme, the illumination changes back to white, the Fog and the sound are switching off.

#### Programme 2: Tropical Rain

After the start of the programme by a button, the light in the shower changes from white to red. A warm Tropical Rain with big, smooth drops patters onto the guest in the shower. You hear birds tweeting. After the end of the programme, the illumination changes back to white, the Tropical Rain and the sound are switching off.

#### Programme 3: Side Nozzles

After the start of the programme by a button, the light in the shower changes from white to green. Cold Side Nozzles massage the guest in the shower. In a distance you hear the sound of waves and sea. After the end of the programme, the illumination changes back to white, the Side Nozzles and the sound are switching off.

#### Programme 4: Siberian Night

The programme starts with a warm Tropical Rain and red light. You hear birds tweeting. In the following the cold, refreshing Fog with very fine droplets works together with the Tropical Rain. A minty, cooling aroma fills the air. The illumination changes to a red-green colour change. In the final programme step you hear a thunderstorm coming and you can see flashlights. The Tropical Rain is working together with the cold Side Nozzles. After the end of the programme the illumination changes back to white, the Tropical Rain, the Side Nozzles and the sound are switching off.

Optionally you can use Waterfall- instead of Side Nozzles for programme 2 and 4.

### SCOPE OF DELIVERY OF A COMPLETE PACKAGE

#### CONTROL PANEL



Control panel incl. listed parts, pre-tubed, pre-wired and pre-mounted on PP board grey - Part no. 14121:

- 1 x Supply cold with pre-filter and ball valve MS 3/4" female thread
- 1 x Supply warm with pre-filter and ball valve MS 1/2" female thread
- Thermomixer JRG 1/2" with non-return valves
- 2 x Outlet with solenoid valve 1/2" and screwing 1/2"
- 1 x Outlet with solenoid valve 3/4" and screwing 3/4"
- Emptying for the tube to the aromatised nozzle
- Fragrance pump with fragrance reservoir and empty switch
- Dosing valve for the injection of aroma into the water tube
- Non-return according to DIN EN 1717
- Microprocessor controller EDS1 in housing

#### TECHNICAL DATA

Electrical supply	230 V-AC, 50 Hz
Power supply	100 W
Water supply	1 x 3/4" female thread and 1 x 1/2" female thread
Dimensions (W/H/D)	750 x 750 x 200 mm
Weight	app. 15 kg

#### PUSH BUTTON

Details see page 72



- 1 x Push-button plate 4-fold stainless steel polished - Part no. 25941
- 1 x Bonnet 4-fold - Part no. 21032-1

#### CEILING ELEMENT INCL. ILLUMINATION

Details see page 76

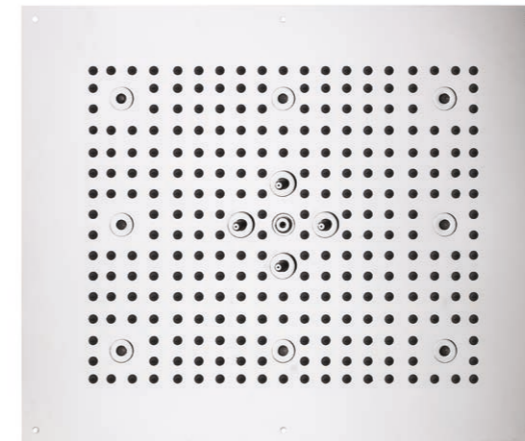

1 x Ceiling element stainless steel chrome optic (Rain Shower, Mist - 8 LED RGB Spots) - Part no. 24980

#### NOZZLES

Details see page 74

- 6 x Side Nozzle - Part no. 19769-2



#### SOUND

Details see page 80



- 1 x Sound module MP3 - Part no. 18824-1
- 1 x Speaker - Part no. 14366-4

#### TO BE PROVIDED BY THE BUILDER

- Plants room for the installation of the control panel
- Power supply
- Water connection cold 3/4"
- Water connection warm 1/2"
- Needed pressure: 3 bar dynamic
- Water quantity: app. 70 l/min
- Drain in the plants room
- Tubing to the nozzles

#### ACCESSORIES / OPTIONS

- Fragrance





## POLAR FLASH SED5 WITH CEILING ELEMENT PVC

### FUNCTION DESCRIPTION

#### Programme 1: Fog Shower with aroma

After the start of the programme by a button, the light in the shower changes from white to a blue-green colour change. A cold, refreshing Fog with very fine droplets starts to spray and a minty, cooling aroma fills the air. In a distance you hear the sound of waves and sea. After the end of the programme, the illumination changes back to white, the Fog and the sound are switching off.

#### Programme 2: Side Nozzles

After the start of the programme by a button, the light in the shower changes from white to green. Cold Side Nozzles massage the guest in the shower. You hear the burbling sound of an alpine creek. After the end of the programme, the illumination changes back to white, the Side Nozzles and the sound are switching off.

#### Programme 3: Cold Rain

After the start of the programme by a button, the light in the shower changes from white to blue. A cold Drizzle refreshes the guest in the shower. You hear birds tweeting. After the end of the programme, the illumination changes back to white, the Drizzle Rain, the Side Nozzles and the sound are switching off.

#### Programme 4: Polar Rain

The programme starts with the cold Side Nozzles and green light. You hear the burbling sound of an alpine creek. In the following the cold, refreshing Fog with very fine droplets works together with the Side Nozzles. A minty, cooling aroma fills the air. The illumination changes to a blue-green colour change. In the final programme step the cold Drizzle is working together with the cold Side Nozzles. After the end of the programme the illumination changes back to white, the Drizzle Rain, the Side Nozzles and the sound are switching off.

### SCOPE OF DELIVERY OF A COMPLETE PACKAGE

#### CONTROL PANEL



Control panel incl. listed parts, pre-tubed, pre-wired and pre-mounted on PP board grey - Part no. 14122:

- 1 x Supply cold with pre-filter and ball valve MS 3/4" female thread
- 2 x Outlet with solenoid valve 1/2" and screwing 1/2"
- 1 x Outlet with solenoid valve 3/4" and screwing 3/4"
- Emptying for the tube to the aromatised nozzle
- Fragrance pump with fragrance reservoir and empty switch
- Dosing valve for the injection of aroma into the water tube
- Non-return according to DIN EN 1717
- Microprocessor controller EDS1 in housing

#### TECHNICAL DATA

Electrical supply	230 V-AC, 50 Hz
Power supply	100 W
Water supply	1 x 3/4" female thread
Dimensions (W/H/D)	750 x 750 x 200 mm
Weight	app. 12 kg

#### PUSH BUTTON

Details see page 72



- 1 x Push-button plate 4-fold Alu-Dibond - Part no. 19014
- 1 x Bonnet 4-fold - Part no. 21032-1
- 1 x Name plate "Cool Fog" - Part no. 17534
- 1 x Name plate "Side Nozzles" - Part no. 18986
- 1 x Name plate "Cold Rain" - Part no. 19036
- 1 x Name plate "Polar Rain" - Part No. 18597

#### CEILING ELEMENT INCL. ILLUMINATION

Details see page 76



1 x Ceiling element PVC white Ø 800 x 19 mm with 3 LED Spots RGB Ø 48 incl. RGB controller SAU and 7 m cable with 4 connections for 4 nozzles - Part no. 21768-3

#### NOZZLES

Details see page 74

- 2 x Drizzle Nozzle 1/2" - Part no. 13527
- 2 x Cover Screen for Drizzle Nozzle - Part no. 13878
- 2 x Fog Nozzle 1/2" - Part no. 13526
- 2 x Cover Screen for Fog Nozzle - Part no. 13877
- 6 x Side Nozzle - Part no. 19769-2



#### SOUND

Details see page 80



- 1 x Sound module MP3 - Part no. 18824-1
- 1 x Speaker - Part no. 14366-4

#### TO BE PROVIDED BY THE BUILDER

- Plants room for the installation of the control panel
- Power supply
- Water connection cold 3/4"
- Needed pressure: 3 bar dynamic
- Water quantity: app. 70 l/min at the use of 2 Drizzle-, 2 Fog- and 6 Side Nozzles
- Drain in the plants room
- Tubing to the nozzles

#### ACCESSORIES / OPTIONS

- Optionally you can use Corian® or backlit ceiling element instead of PVC
- Fragrance





## POLAR FLASH SED5 WITH CEILING ELEMENT STAINLESS STEEL

### FUNCTION DESCRIPTION

#### Programme 1: Fog Shower with aroma

After the start of the programme by a button, the light in the shower changes from white to a blue-green colour change. A cold, refreshing Fog with very fine droplets starts to spray and a minty, cooling aroma fills the air. In a distance you hear the sound of waves and sea. After the end of the programme, the illumination changes back to white, the Fog and the sound are switching off.

#### Programme 2: Side Nozzles

After the start of the programme by a button, the light in the shower changes from white to green. Cold Side Nozzles massage the guest in the shower. You hear the burbling sound of an alpine creek. After the end of the programme, the illumination changes back to white, the Side Nozzles and the sound are switching off.

#### Programme 3: Cold Rain

After the start of the programme by a button, the light in the shower changes from white to blue. A cold Rain refreshes the guest in the shower. You hear birds tweeting. After the end of the programme, the illumination changes back to white, the Drizzle and the sound are switching off.

#### Programme 4: Polar Rain

The programme starts with the cold Side Nozzles and green light. You hear the burbling sound of an alpine creek. In the following the cold, refreshing Fog with very fine droplets works together with the Side Nozzles. A minty, cooling aroma fills the air. The illumination changes to a blue-green colour change. In the final programme step the cold Rain is working together with the cold Side Nozzles. After the end of the programme the illumination changes back to white, the Rain, the Side Nozzles and the sound are switching off.

### SCOPE OF DELIVERY OF A COMPLETE PACKAGE

#### CONTROL PANEL



Control panel incl. listed parts, pre-tubed, pre-wired and pre-mounted on PP board grey - Part no. 14122:

- 1 x Supply cold with pre-filter and ball valve MS 3/4" female thread
- 2 x Outlet with solenoid valve 1/2" and screwing 1/2"
- 1 x Outlet with solenoid valve 3/4" and screwing 3/4"
- Emptying for the tube to the aromatised nozzle
- Fragrance pump with fragrance reservoir and empty switch
- Dosing valve for the injection of aroma into the water tube
- Non-return according to DIN EN 1717
- Microprocessor controller EDS1 in housing

#### TECHNICAL DATA

Electrical supply	230 V-AC, 50 Hz
Power supply	100 W
Water supply	1 x 3/4" female thread
Dimensions (W/H/D)	750 x 750 x 200 mm
Weight	app. 12 kg

#### PUSH BUTTON

Details see page 72



- 1 x Push-button plate 4-fold stainless steel polished - Part no. 25941
- 1 x Bonnet 4-fold - Part no. 21032-1

#### CEILING ELEMENT INCL. ILLUMINATION

Details see page 76

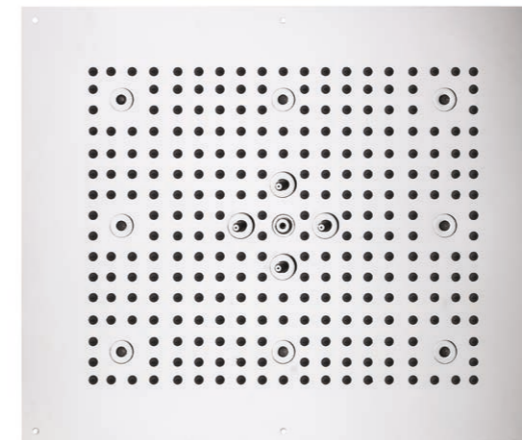

- 1 x Ceiling element stainless steel chrome optic (Rain Shower, Mist - 8 LED RGB Spots) - Part no. 24980

#### NOZZLES

Details see page 74

- 6 x Side Nozzle - Part no. 19769-2



#### SOUND

Details see page 80



- 1 x Sound module MP3 - Part no. 18824-1
- 1 x Speaker - Part no. 14366-4

#### TO BE PROVIDED BY THE BUILDER

- Plants room for the installation of the control panel
- Power supply
- Water connection cold 3/4"
- Needed pressure: 3 bar dynamic
- Water quantity: app. 70 l/min
- Drain in the plants room
- Tubing to the nozzles

#### ACCESSORIES / OPTIONS

- Fragrance





## TROPICA SED6 WITH CEILING ELEMENT PVC

### FUNCTION DESCRIPTION

#### Programme 1: Tropical Rain with aroma

After the start of the programme by a button, the light in the shower changes from white to red. A warm Tropical Rain with big, smooth drops patters onto the guest in the shower. You hear birds tweeting and a fruity, lively aroma fills the air. After the end of the programme, the illumination changes back to white, the rain and the sound are switching off.

#### Programme 2: Fog Shower

After the start of the programme by a button, the light in the shower changes from white to blue. A cold, refreshing Fog with very fine droplets starts to spray. In a distance you hear the sound of waves and sea. After the end of the programme, the illumination changes back to white, the Fog and the sound are switching off.

#### Programme 3: Tropical Storm

The programme starts with the cold, refreshing Fog Shower and blue light. In a distance, you hear the sound of waves and sea. In the following, the warm Tropical Rain with big, smooth drops increases the water volume and works together with the cold Fog. The illumination in the shower changes to a red-green colour change and a fruity, lively aroma fills the air. In the last step of the programme, the warm Tropical Rain stops and the programme finishes with the cold Fog and blue light. After the end of the programme, the illumination changes back to white, the Fog and the sound are switching off.

### SCOPE OF DELIVERY OF A COMPLETE PACKAGE

#### CONTROL PANEL



Control panel incl. listed parts, pre-tubed, pre-wired and pre-mounted on PP board grey - Part no. 14245:

- 2 x Supply with pre-filter and ball valve MS 1/2" female thread
- Thermomixer JRG 1/2" with non-return valves
- 2 x Outlet with solenoid valve 1/2" and screwing 1/2"
- Emptying for the tube to the aromatised nozzle
- Fragrance pump with fragrance reservoir and empty switch
- Dosing valve for the injection of aroma into the water tube
- Non-return according to DIN EN 1717
- Microprocessor controller EDS1 in housing

#### TECHNICAL DATA

Electrical supply	230 V-AC, 50 Hz
Power supply	100 W
Water supply	2 x 1/2" female thread
Dimensions (W/H/D)	750 x 750 x 200 mm
Weight	app. 12 kg

#### PUSH BUTTON

Details see page 72



- 1 x Push-button plate 3-fold Alu-Dibond - Part no. 19013
- 1 x Bonnet 3-fold - Part no. 21031-1
- 1 x Name plate "Tropical Rain" - Part no. 17528
- 1 x Name plate "Cool Fog" - Part no. 17534
- 1 x Name plate "Tropical Storm" - Part No. 23923

#### CEILING ELEMENT INCL. ILLUMINATION

Details see page 76



1 x Ceiling element PVC white Ø 800 x 19 mm with 3 LED Spots RGB Ø 48 incl. RGB controller SAU and 7 m cable with 4 connections for 4 nozzles - Part no. 21768-3

#### NOZZLES

Details see page 74

- 2 x Rain Nozzle 1/2" - Part no. 13528
- 2 x Cover Screen for Rain Nozzle - Part no. 13879
- 2 x Fog Nozzle 1/2" - Part no. 13526
- 2 x Cover Screen for Fog Nozzle - Part no. 13877

#### SOUND

Details see page 80



- 1 x Sound module MP3 - Part no. 18824-1
- 1 x Speaker - Part no. 14366-4

#### TO BE PROVIDED BY THE BUILDER

- Plants room for the installation of the control panel
- Power supply
- Water connection cold 1/2"
- Water connection warm 1/2"
- Needed pressure: 3 bar dynamic
- Water quantity: app. 60 l/min at the use of 2 Rain- and 2 Fog Nozzles
- Drain in the plants room
- Tubing to the nozzles

#### ACCESSORIES / OPTIONS

- Optionally you can use Corian® or backlit ceiling element instead of PVC
- Fragrance





## TROPICA SED6 WITH CEILING ELEMENT STAINLESS STEEL

### FUNCTION DESCRIPTION

#### Programme 1: Tropical Rain with aroma

After the start of the programme by a button, the light in the shower changes from white to red. A warm Tropical Rain with big, smooth drops patters onto the guest in the shower. You hear birds tweeting and a fruity, lively aroma fills the air. After the end of the programme, the illumination changes back to white, the rain and the sound are switching off.

#### Programme 2: Fog Shower

After the start of the programme by a button, the light in the shower changes from white to blue. A cold, refreshing Fog with very fine droplets starts to spray. In a distance you hear the sound of waves and sea. After the end of the programme, the illumination changes back to white, the Fog and the sound are switching off.

#### Programme 3: Tropical Storm

The programme starts with the cold, refreshing Fog Shower and blue light. In a distance, you hear the sound of waves and sea. In the following, the warm Tropical Rain with big, smooth drops increases the water volume and works together with the cold Fog. The illumination in the shower changes to a red-green colour change and a fruity, lively aroma fills the air. In the last step of the programme, the warm Tropical Rain stops and the programme finishes with the cold Fog and blue light. After the end of the programme, the illumination changes back to white, the Fog and the sound are switching off.

### SCOPE OF DELIVERY OF A COMPLETE PACKAGE

#### CONTROL PANEL



Control panel incl. listed parts, pre-tubed, pre-wired and pre-mounted on PP board grey - Part no. 14245:

- 2 x Supply with pre-filter and ball valve MS 1/2" female thread
- Thermomixer JRG 1/2" with non-return valves
- 2 x Outlet with solenoid valve 1/2" and screwing 1/2"
- Emptying for the tube to the aromatised nozzle
- Fragrance pump with fragrance reservoir and empty switch
- Dosing valve for the injection of aroma into the water tube
- Non-return according to DIN EN 1717
- Microprocessor controller EDS1 in housing

#### TECHNICAL DATA

Electrical supply	230 V-AC, 50 Hz
Power supply	100 W
Water supply	2 x 1/2" female thread
Dimensions (W/H/D)	750 x 750 x 200 mm
Weight	app. 12 kg

#### PUSH BUTTON

Details see page 72



- 1 x Push-button plate 3-fold stainless steel polished - Part no. 25940
- 1 x Bonnet 3-fold - Part no. 21031-1

#### CEILING ELEMENT INCL. ILLUMINATION

Details see page 76

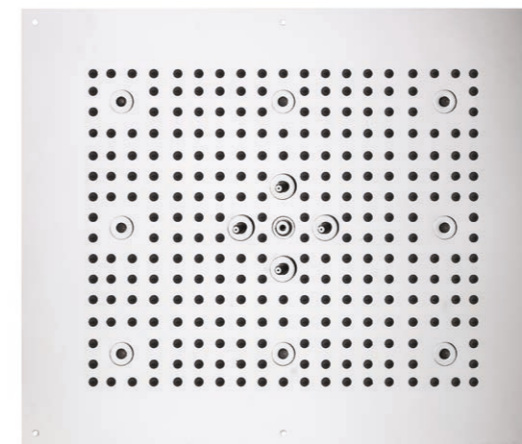

- 1 x Ceiling element stainless steel chrome optic (Rain Shower, Mist - 8 LED RGB Spots) - Part no. 24980

#### SOUND

Details see page 80



- 1 x Sound module MP3 - Part no. 18824-1
- 1 x Speaker - Part no. 14366-4

#### TO BE PROVIDED BY THE BUILDER

- Plants room for the installation of the control panel
- Power supply
- Water connection cold 1/2"
- Water connection warm 1/2"
- Needed pressure: 3 bar dynamic
- Water quantity: app. 40 l/min
- Drain in the plants room
- Tubing to the nozzles

#### ACCESSORIES / OPTIONS

- Fragrance





## ATLANTIC OCEAN RA1 WITH CEILING ELEMENT PVC

### FUNCTION DESCRIPTION

#### Programme 1: Fog Shower with aroma

After the start of the programme by a button, the light in the shower changes from white to blue. A cold, refreshing Fog with very fine droplets starts to spray and a minty, cooling aroma fills the air. In a distance you hear the roll of thunder. After the end of the programme, the illumination changes back to white, the Fog and the sound are switching off.

#### Programme 2: Atlantic Ocean

The programme starts with a warm Drizzle Rain. The illumination in the shower changes to a red-green-blue colour change. In a distance you hear the sound of waves and sea. After an adjustable time an additional Fog cools the temperature down. A minty, refreshing aroma fills the air. In the last step of the programme the cold Fog is replaced by a warm Tropical Rain.

#### Programme 3: Tropical Rain with aroma

After the start of the programme by a button, the light in the shower changes from white to red. A warm Tropical Rain with big, smooth drops patters onto the guest in the shower. You hear birds tweeting and a fruity, lively aroma fills the air. After the end of the programme, the illumination changes back to white, the Tropical Rain and the sound are switching off.

#### Programme 4: Caribbean Rain

After the start of the programme by a button a warm String Rain starts to spray. The illumination in the shower changes to a red-green colour change. You hear the burbling sound of an alpine creek. After an adjustable time a warm Tropical Rain with big, smooth drops increases the water volume. A fruity, lively aroma fills the air. Then the rain gets weaker again and the programme lapses with the warm String Rain. After the end of the programme the illumination changes back to white, the String Rain and the sound are switching off.

### SCOPE OF DELIVERY OF A COMPLETE PACKAGE

#### CONTROL PANEL

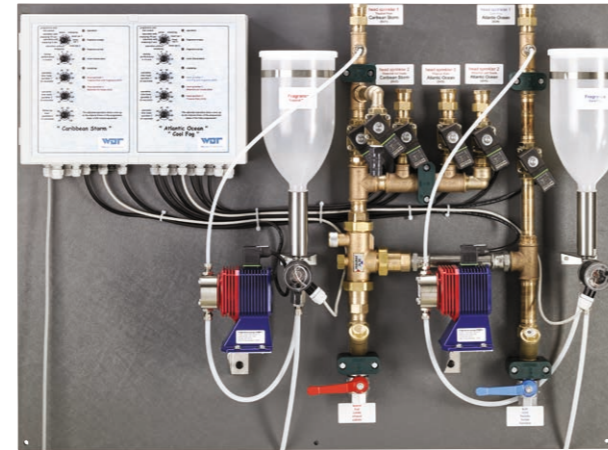

Control panel incl. listed parts, pre-tubed, pre-wired and pre-mounted on PP board grey - Part no. 16639:

- 2 x Supply with pre-filter and ball valve MS 3/4" female thread
- Thermomixer JRG 3/4" with non-return valves
- 5 x Outlet with solenoid valve 1/2" and screwing 1/2"
- Emptying for the tube to the aromatised rain nozzle
- 2 x Fragrance pump with fragrance reservoir and empty switch
- 2 x Dosing valve for the injection of aroma into the water tube
- 2 x Microprocessor controller EDS1 in housing

#### TECHNICAL DATA

Electrical supply	230 V-AC, 50 Hz
Power supply	150 W
Water supply	2 x 3/4" female thread
Dimensions (W/H/D)	1000 x 750 x 200 mm
Weight	app. 20 kg

#### PUSH BUTTON

Details see page 72



- 1 x Push-button plate 4-fold Alu-Dibond - Part no. 19014
- 1 x Bonnet 4-fold - Part no. 21032-1
- 1 x Name plate "Cool Fog" - Part no. 17534
- 1 x Name plate "Atlantic Ocean" - Part no. 18596
- 1 x Name plate "Tropical Rain" - Part no. 17528
- 1 x Name plate "Caribbean Rain" - Part No. 23447

#### CEILING ELEMENT INCL. ILLUMINATION

Details see page 76



- 1 x Ceiling element PVC white Ø 800 x 19 mm with 3 LED Spots RGB Ø 48 incl. RGB controller SAU and 7 m cable with 7 connections for 7 nozzles - Part no. 21771-1

#### NOZZLES

Details see page 74

- 1 x Rain Nozzle 1/2" - Part no. 13528
- 1 x Cover Screen for Rain Nozzle - Part no. 13879
- 1 x Fog Nozzle 1/2" - Part no. 13526
- 1 x Cover Screen for Fog Nozzle - Part no. 13877
- 2 x Drizzle Nozzle 1/2" - Part no. 13527
- 2 x Cover Screen for Drizzle Nozzle - Part no. 13878
- 3 x String Nozzle 1/2" - Part no. 16593
- 3 x Cover Screen for Fog Nozzle - Part no. 13879

#### SOUND

Details see page 80



- 1 x Sound module MP3 - Part no. 18824-1
- 1 x Speaker - Part no. 14366-4

#### TO BE PROVIDED BY THE BUILDER

- Plants room for the installation of the control panel
- Power supply
- Water connection cold 3/4"
- Water connection warm 3/4"
- Needed pressure: 3 bar dynamic
- Water quantity: app. 60 l/min
- Drain in the plants room
- Tubing to the nozzles
- 2 x Non-return according to DIN EN 1717

#### ACCESSORIES / OPTIONS

- Optionally you can use Corian® or backlit ceiling element instead of PVC
- Fragrance





## ATLANTIC OCEAN RA1 WITH CEILING ELEMENT STAINLESS STEEL

### FUNCTION DESCRIPTION

#### Programme 1: Fog Shower with aroma

After the start of the programme by a button, the light in the shower changes from white to blue. A cold, refreshing Fog with very fine droplets starts to spray and a minty, cooling aroma fills the air. You hear the roll of thunder. After the end of the programme, the illumination changes back to white, the Fog and the sound are switching off.

#### Programme 2: Atlantic Ocean

The programme starts with a warm Waterfall Part Blade. The illumination in the shower changes to a red-green-blue colour change. In a distance you hear the sound of waves and sea. After an adjustable time an additional Fog cools the temperature down. A minty, refreshing aroma fills the air. In the last step of the programme a warm Tropical Rain replaces the cold Fog.

#### Programme 3: Tropical Rain with aroma

After the start of the programme by a button, the light in the shower changes from white to red. A warm Tropical Rain with big, smooth drops patters onto the guest in the shower. You hear birds tweeting and a fruity, lively aroma fills the air. After the end of the programme, the illumination changes back to white, the Tropical Rain and the sound are switching off.

#### Programme 4: Caribbean Rain

After the start of the programme by a button, a warm Waterfall Full Blade starts to spray. The illumination in the shower changes to a red-green colour change. You hear the burbling sound of an alpine creek. After an adjustable time a warm Tropical Rain with big, smooth drops increases the water volume. A fruity, lively aroma fills the air. Then the rain gets weaker again and the programme lapses with the warm Waterfall Full Blade. After the end of the programme the illumination changes back to white.

### SCOPE OF DELIVERY OF A COMPLETE PACKAGE

#### CONTROL PANEL

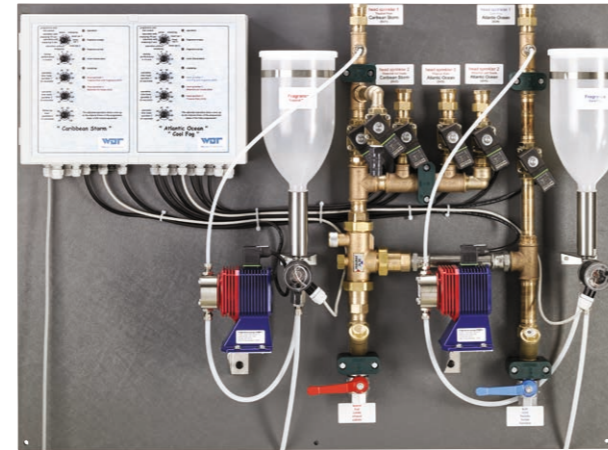

Control panel incl. listed parts, pre-tubed, pre-wired and pre-mounted on PP board grey - Part no. 16639:

- 2 x Supply with pre-filter and ball valve MS 3/4" female thread
- Thermomixer JRG 3/4" with non-return valves
- 5 x Outlet with solenoid valve 1/2" and screwing 1/2"
- Emptying for the tube to the aromatised rain nozzle
- 2 x Fragrance pump with fragrance reservoir and empty switch
- 2 x Dosing valve for the injection of aroma into the water tube
- 2 x Microprocessor controller EDS1 in housing

#### TECHNICAL DATA

Electrical supply	230 V-AC, 50 Hz
Power supply	150 W
Water supply	2 x 3/4" female thread
Dimensions (W/H/D)	1000 x 750 x 200 mm
Weight	app. 20 kg

#### PUSH BUTTON

Details see page 72



- 1 x Push-button plate 4-fold stainless steel polished - Part no. 25941
- 1 x Bonnet 4-fold - Part no. 21032-1

#### CEILING ELEMENT INCL. ILLUMINATION

Details see page 76

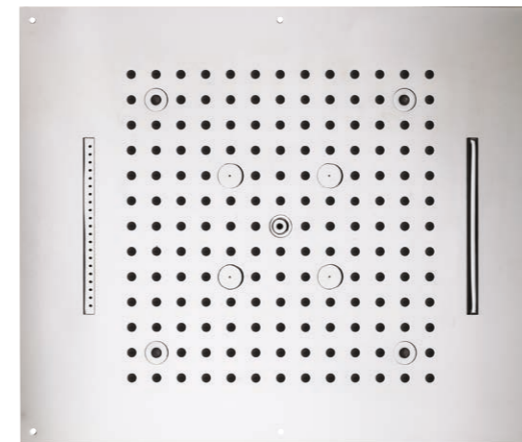

1 x Ceiling element stainless steel chrome optic (Rain Shower, Waterfall Full Blade, Waterfall Part Blade, Mist - 4 LED RGB Spots) - Part no. 24651

#### SOUND

Details see page 80



- 1 x Sound module MP3 - Part no. 18824-1
- 1 x Speaker - Part no. 14366-4

#### TO BE PROVIDED BY THE BUILDER

- Plants room for the installation of the control panel
- Power supply
- Water connection cold 3/4"
- Water connection warm 3/4"
- Needed pressure: 3 bar dynamic
- Water quantity: app. 50 l/min
- Drain in the plants room
- Tubing to the nozzles
- 2 x Non-return according to DIN EN 1717

#### ACCESSORIES / OPTIONS

- Fragrance



## TROPICAL THUNDER RA2 WITH CEILING ELEMENT PVC

### FUNCTION DESCRIPTION

#### Programme 1: Tropical Rain

After the start of the programme by a button the light in the shower changes from white to a red-green colour change and a soft, warm Drizzle Rain patters onto the guest in the shower. You hear birds tweeting. In the following, a warm String Rain starts. A fruity, lively aroma fills the air. Now a cold Drizzle Rain cools the temperature down. Then the cold Drizzle stops and the programme finishes with a warm Drizzle and the aromatised String Rain. After the end of the programme the illumination changes from the red-green colour change back to white, the warm Drizzle and the aromatised String Rain are switching off.

#### Programme 2: Caribbean Rain

The programme starts with a warm Drizzle Rain and red light. In a distance you hear the sound of waves and sea. After an adjustable time the light changes to green and a cold, refreshing Fog with very fine droplets refreshes the user. A minty, cooling aroma fills the air. In the following the warm Drizzle stops and the cold Fog continues. Now a warm Tropical Rain with blue light starts and then goes over into a warm Drizzle. You hear a thunderstorm coming and you see flashlights. In the next step a cold Drizzle Rain replaces the cold Fog. The scenario lapses with a warm Drizzle Rain and red light. After the end of the programme the illumination changes back to white, the Drizzle Rain and the sound are switching off.

### SCOPE OF DELIVERY OF A COMPLETE PACKAGE

#### CONTROL PANEL



Control panel incl. listed parts, pre-tubed, pre-wired and pre-mounted on PP board grey - Part no. 19290:

- 2 x Supply with pre-filter and ball valve MS 3/4" female thread
- Thermomixer JRG 3/4" with non-return valves
- 6 x Outlet with solenoid valve 1/2" and screwing 1/2"
- Emptying for the tube to the aromatised rain nozzle
- 2 x Fragrance pump with fragrance reservoir and empty switch
- 2 x Dosing valve for the injection of aroma into the water tube
- 2 x Microprocessor controller EDS1 in housing

#### TECHNICAL DATA

Electrical supply	230 V-AC, 50 Hz
Power supply	150 W
Water supply	2 x 3/4" female thread
Dimensions (W/H/D)	1000 x 750 x 200 mm
Weight	app. 20 kg

#### PUSH BUTTON

Details see page 72



- 1 x Push-button plate 2-fold Alu-Dibond - Part no. 19012
- 1 x Bonnet 2-fold - Part no. 21034-1
- 1 x Name plate "Tropical Rain" - Part no. 17528
- 1 x Name plate "Caribbean Rain" - Part No. 23447

#### CEILING ELEMENT INCL. ILLUMINATION

Details see page 76



1 x Ceiling element PVC white Ø 800 x 19 mm with 3 LED Spots RGB Ø 48 incl. RGB controller SAU and 7 m cable with 11 connections for 11 nozzles - Part no. 21772-1

#### NOZZLES

Details see page 74

- 1 x Rain Nozzle 1/2" - Part no. 13528
- 1 x Cover Screen for Rain Nozzle - Part no. 13879
- 2 x Fog Nozzle 1/2" - Part no. 13526
- 2 x Cover Screen for Fog Nozzle - Part no. 13877
- 5 x Drizzle Nozzle 1/2" - Part no. 13527
- 5 x Cover Screen for Drizzle Nozzle - Part no. 13878
- 3 x String Nozzle 1/2" - Part no. 16593
- 3 x Cover Screen for Fog Nozzle - Part no. 13879

#### SOUND

Details see page 80



- 1 x Sound module MP3 - Part no. 18824-1
- 1 x Speaker - Part no. 14366-4

#### TO BE PROVIDED BY THE BUILDER

- Plants room for the installation of the control panel
- Power supply
- Water connection cold 3/4"
- Water connection warm 3/4"
- Needed pressure: 3 bar dynamic
- Water quantity: app. 60 l/min
- Drain in the plants room
- Tubing to the nozzles
- 2 x Non-return according to DIN EN 1717

#### ACCESSORIES / OPTIONS

- Optionally you can use Corian® or backlit ceiling element instead of PVC
- Fragrance





## TROPICAL THUNDER RA2 WITH CEILING ELEMENT STAINLESS STEEL

### FUNCTION DESCRIPTION

#### Programme 1: Tropical Rain

After the start of the programme by a button the light in the shower changes from white to a red-green colour change and a soft, warm Waterfall Part Blade patters onto the guest in the shower. You hear birds tweeting. In the following, a warm Tropical Rain starts. A fruity, lively aroma fills the air. Now a cold Fog cools the temperature down. Then the cold Fog stops and the programme finishes with a warm Fog and the aromatised Tropical Rain. After the end of the programme the illumination changes from the red-green colour change back to white, the warm Fog and the aromatised Tropical Rain are switching off.

#### Programm 2: Caribbean Rain

The programme starts with a warm Waterfall Part Blade and red light. In a distance you hear the sound of waves and sea. After an adjustable time the light changes to green and a cold, refreshing Fog with very fine droplets refreshes the user. A minty, cooling aroma fills the air. In the following the warm Waterfall Part Blade stops and the cold Fog continues. Now a warm Waterfall Full Blade with blue light starts and then goes over into a warm Waterfall Part Blade. You hear a thunderstorm coming and you see flashlights. The scenario lapses with a warm Waterfall Part Blade and red light. After the end of the programme the illumination changes back to white.

### SCOPE OF DELIVERY OF A COMPLETE PACKAGE

#### CONTROL PANEL



Control panel incl. listed parts, pre-tubed, pre-wired and pre-mounted on PP board grey - Part no. 19290:

- 2 x Supply with pre-filter and ball valve MS 3/4" female thread
- Thermomixer JRG 3/4" with non-return valves
- 6 x Outlet with solenoid valve 1/2" and screwing 1/2"
- Emptying for the tube to the aromatised rain nozzle
- 2 x Fragrance pump with fragrance reservoir and empty switch
- 2 x Dosing valve for the injection of aroma into the water tube
- 2 x Microprocessor controller EDS1 in housing

#### TECHNICAL DATA

Electrical supply	230 V-AC, 50 Hz
Power supply	150 W
Water supply	2 x 3/4" female thread
Dimensions (W/H/D)	1000 x 750 x 200 mm
Weight	app. 20 kg

#### PUSH BUTTON

Details see page 72



- 1 x Push-button plate 2-fold stainless steel polished - Part no. 25943
- 1 x Bonnet 2-fold - Part no. 21034-1

#### CEILING ELEMENT INCL. ILLUMINATION

Details see page 76

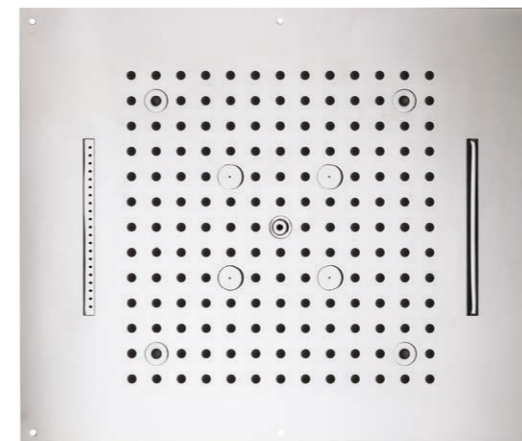

1 x Ceiling element stainless steel chrome optic (Rain Shower, Waterfall Full Blade, Waterfall Part Blade, Mist - 4 LED RGB Spots) - Part no. 24651

#### SOUND

Details see page 80



- 1 x Sound module MP3 - Part no. 18824-1
- 1 x Speaker - Part no. 14366-4

#### TO BE PROVIDED BY THE BUILDER

- Plants room for the installation of the control panel
- Power supply
- Water connection cold 3/4"
- Water connection warm 3/4"
- Needed pressure: 3 bar dynamic
- Water quantity: app. 70 l/min
- Drain in the plants room
- Tubing to the nozzles
- 2 x Non-return according to DIN EN 1717

#### ACCESSORIES / OPTIONS

- Fragrance



# WATER FUN ID1 WITH CEILING ELEMENT PVC

## FUNCTION DESCRIPTION

### Programme 1: Water Fun

After the start of the programme by a button, the light in the shower changes from white to blue. A cold, refreshing Fog with very fine droplets starts to spray and a minty, cooling aroma fills the air. In a distance you hear the sound of waves and sea. Now the lowest pair of side nozzles at the level of the legs starts to spray cold water. After an adjustable time the pair of nozzles at the level of the hips follows, then the pair of nozzles at the level of the upper body. Now the temperature changes from cold to warm water, the light changes to red and the three pairs of side nozzles work in the opposite direction. The programme lapses with the cold aromatised Fog. After the end of the programme, the illumination changes back to white and the nozzles are switching off.

### Programme 2: Tropical Rain

The programme starts with a warm Drizzle and a red-green colour change. A fruity, lively aroma fills the air. You hear birds tweeting. After an adjustable time a warm Tropical Rain with big, smooth drops patters additionally onto the guest in the shower. Now the rain is getting weaker and the programme lapses with the warm Drizzle. After the end of the programme the illumination changes back to white, the Drizzle with aroma and the sound are switching off.

### Programme 3: Mediterranean

The programme starts with a cold Fog and a red-green-blue colour change. In a distance you hear the roll of thunder. After an adjustable time a soft, warm Drizzle is added. In the following, the cold Fog stops and the programme lapses with the warm Drizzle. After the end of the programme the illumination changes back to white, the Drizzle and the sound are switching off.

## SCOPE OF DELIVERY OF A COMPLETE PACKAGE

### CONTROL PANEL



Control panel incl. listed parts, pre-tubed, pre-wired and pre-mounted on PP board grey - Part no. 18987:

- 2 x Supply with pre-filter and ball valve MS 3/4" female thread
- Thermomixer JRG 3/4" with non-return valves
- 8 x Outlet with solenoid valve 1/2" and screwing 1/2"
- 2 x Solenoid valve for cold-warm change
- 2 x Emptying for the tube to the aromatised nozzles
- 2 x Fragrance pump with fragrance reservoir and empty switch
- 2 x Dosing valve for the injection of aroma into the water tube
- 2 x Microprocessor controller EDS1 in housing

### TECHNICAL DATA

Electrical supply	230 V-AC, 50 Hz
Power supply	150 W
Water supply	2 x 3/4" female thread
Dimensions (W/H/D)	1200 x 750 x 200 mm
Weight	app. 25 kg

### PUSH BUTTON

Details see page 72



- 1 x Push-button plate 3-fold Alu-Dibond - Part no. 19013
- 1 x Bonnet 3-fold - Part no. 21031-1
- 1 x Name plate "Water Fun" - Part no. 19035
- 1 x Name plate "Tropical Rain" - Part no. 17528
- 1 x Name plate "Mediterranean" - Part No. 19034

### CEILING ELEMENT INCL. ILLUMINATION

Details see page 76



1 x Ceiling element PVC white Ø 800 x 19 mm with 3 LED Spots RGB Ø 48 incl. RGB controller SAU and 7 m cable with 6 connections for 6 nozzles - Part no. 21770-1

### NOZZLES

Details see page 74

- 2 x Fog Nozzle 1/2" - Part no. 13526
- 2 x Cover Screen for Fog Nozzle - Part no. 13877
- 2 x Drizzle Nozzle 1/2" - Part no. 13527
- 2 x Cover Screen for Drizzle Nozzle - Part no. 13878
- 2 x Rain Nozzle 1/2" - Part no. 13528
- 2 x Cover Screen for Rain Nozzle - Part no. 13879
- 6 x Side Nozzle - Part no. 19769-2



### SOUND

Details see page 80



- 1 x Sound module MP3 - Part no. 18824-1
- 1 x Speaker - Part no. 14366-4

### TO BE PROVIDED BY THE BUILDER

- Plants room for the installation of the control panel
- Power supply
- Water connection cold 3/4"
- Water connection warm 3/4"
- Needed pressure: 3 bar dynamic
- Water quantity: app. 60 l/min
- Drain in the plants room
- Tubing to the nozzles
- 2 x Non-return according to DIN EN 1717

### ACCESSORIES / OPTIONS

- Optionally you can use Corian® or backlit ceiling element instead of PVC
- Fragrance





# WATER FUN ID1 WITH CEILING ELEMENT STAINLESS STEEL

## FUNCTION DESCRIPTION

### Programme 1: Water Fun

After the start of the programme by a button, the light in the shower changes from white to blue. A cold, refreshing Fog with very fine droplets starts to spray and a minty, cooling aroma fills the air. In a distance you hear the sound of waves and sea. Now the lowest pair of side nozzles at the level of the legs starts to spray cold water. After an adjustable time the pair of nozzles at the level of the hips follows, then the pair of nozzles at the level of the upper body. Now the temperature changes from cold to warm water, the light changes to red and the three pairs of side nozzles work in the opposite direction. The programme lapses with the cold aromatised Fog. After the end of the programme, the illumination changes back to white and the nozzles are switching off.

### Programme 2: Tropical Rain

The programme starts with a warm Tropical Rain and a red-green colour change. A fruity, lively aroma fills the air. You hear birds tweeting. After an adjustable time two warm Waterfalls (Part- and Full Blade) patter additionally onto the guest in the shower. Now the rain is getting weaker again and the programme lapses with the warm Tropical Rain. After the end of the programme the illumination changes back to white, the Tropical Rain with aroma and the sound are switching off.

### Programme 3: Mediterranean

The programme starts with a cold Fog and a red-green-blue colour change. In a distance you hear the roll of thunder. After an adjustable time a soft, warm Tropical Rain is added. In the following, the cold Fog stops and the programme lapses with the warm Tropical Rain. After the end of the programme the illumination changes back to white, the Rain and the sound are switching off.

## SCOPE OF DELIVERY OF A COMPLETE PACKAGE

### CONTROL PANEL



Control panel incl. listed parts, pre-tubed, pre-wired and pre-mounted on PP board grey - Part no. 18987:

- 2 x Supply with pre-filter and ball valve MS 3/4" female thread
- Thermomixer JRG 3/4" with non-return valves
- 8 x Outlet with solenoid valve 1/2" and screwing 1/2"
- 2 x Solenoid valve for cold-warm change
- 2 x Emptying for the tube to the aromatised nozzles
- 2 x Fragrance pump with fragrance reservoir and empty switch
- 2 x Dosing valve for the injection of aroma into the water tube
- 2 x Microprocessor controller EDS1 in housing

### TECHNICAL DATA

Electrical supply	230 V-AC, 50 Hz
Power supply	150 W
Water supply	2 x 3/4" female thread
Dimensions (W/H/D)	1200 x 750 x 200 mm
Weight	app. 25 kg

### PUSH BUTTON

Details see page 72



- 1 x Push-button plate 3-fold stainless steel polished - Part no. 25940
- 1 x Bonnet 3-fold - Part no. 21031-1

### CEILING ELEMENT INCL. ILLUMINATION

Details see page 76

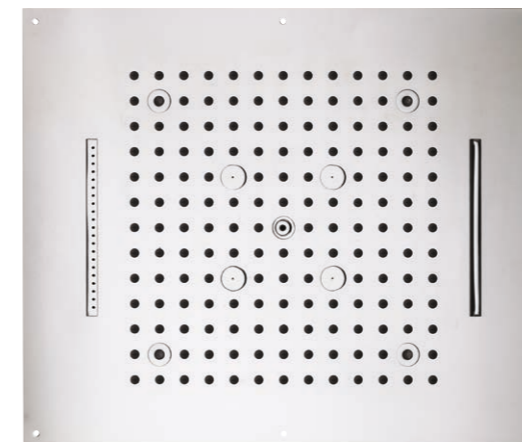

1 x Ceiling element stainless steel chrome optic (Rain Shower, Waterfall Full Blade, Waterfall Part Blade, Mist - 4 LED RGB Spots) - Part no. 24651

### NOZZLES

Details see page 74

6 x Side Nozzle - Part no. 19769-2



### SOUND

Details see page 80



- 1 x Sound module MP3 - Part no. 18824-1
- 1 x Speaker - Part no. 14366-4

### TO BE PROVIDED BY THE BUILDER

- Plants room for the installation of the control panel
- Power supply
- Water connection cold 3/4"
- Water connection warm 3/4"
- Needed pressure: 3 bar dynamic
- Water quantity: app. 70 l/min
- Drain in the plants room
- Tubing to the nozzles
- 2 x Non-return according to DIN EN 1717

### ACCESSORIES / OPTIONS

- Fragrance





## SHOWER TUNNEL

Shower Tunnels create a unique and exciting experience. The user is automatically guided through the single zones of the tunnel and enjoys one experience after the other. The programs starts by the push of a button or automatically by the use of light barriers at the entrance of the tunnel.



## MAGICAL MOMENTS

- » Creation of unique dream worlds with individual configuration
- » Multiple design options with ceiling elements made of PVC, Stainless Steel or Corian®
- » The number of zones can be adapted easily to the project requirements
- » Sustainable shower pleasure: only the currently used zone is activate

**We consult you with pleasure about detailed configuration possibilities**





## SHOWER TUNNEL WITH CEILING ELEMENTS PVC WITH 3 ZONES

### FUNCTION DESCRIPTION

In standby mode all zones are illuminated white. Once the tunnel has been activated, the white light switches-off and only the currently activated zone is illuminated. The overlap time between the single zones is three seconds. The shower walk starts with a warm, aromatised Drizzle Rain and red lights. Birds tweeting. At the second station, a cold String Rain patters on the guest in the shower, the illumination changes to blue. You hear crashing of waves. In the third zone a warm Tropical Rain starts, flashlights fill the room and you hear the roll of thunder. In the following the second station will surprisingly be activated again with a cold Fog. A blue-green colour change fills the room and you hear the crashing of waves again. The programme lapses in the third station with a warm Drizzle Rain. The lights shines yellow and you hear a final roll of thunder. Afterwards the tunnel is ready for a restart.

### SCOPE OF DELIVERY OF A COMPLETE PACKAGE

#### CONTROL PANEL



Control panel incl. listed parts, pre-tubed, pre-wired and pre-mounted on PP board grey - Part no. 19374-1:

- 2 x Supply with pre-filter and ball valve MS 1" female thread
- Thermomixer JRG 3/4" with non-return valves
- 3 x Outlet with solenoid valve warm 3/4" and screwing 3/4"
- 2 x Outlet with solenoid valve cold 3/4" and screwing 3/4"
- 1 x Fragrance pump with fragrance reservoir and empty switch
- 1 x Dosing valve for the injection of aroma into the water tube
- 1 x Microprocessor controller EDS1 in housing

#### TECHNICAL DATA

Electrical supply	230 V-AC, 50 Hz
Power supply	150 W
Water supply	2 x 1" female thread
Dimensions (W/H/D)	1000 x 750 x 200 mm
Weight	app. 20 kg

#### PUSH BUTTON

Details see page 72



- 1 x Push-button plate 1-fold Alu-Dibond - Part no. 19011
- 1 x Bonnet 1-fold - Part no. 21030-1
- 1 x Name plate "Start" - Part no. 17219

#### CEILING ELEMENT INCL. ILLUMINATION

Details see page 76



Example photo

2 x Ceiling element PVC white 700 x 700 mm, 2 cm with 3 LED Spots RGB MS chromed incl. RGB controller SAU and 7 m cable with 3 connections for 3 nozzles - Part no. 24948

1 x Ceiling element PVC white 700 x 700 mm, 2 cm with 3 LED Spots RGB MS chromed incl. RGB controller SAU and 7 m cable with 6 connections for 6 nozzles - Part no. 24946

#### NOZZLES

Details see page 74

- 3 x Rain Nozzle 1/2" - Part no. 13528
- 3 x Cover Screen for Rain Nozzle - Part no. 13879
- 3 x Fog Nozzle 1/2" - Part no. 13526
- 3 x Cover Screen for Fog Nozzle - Part no. 13877
- 6 x Drizzle Nozzle 1/2" - Part no. 13527
- 6 x Cover Screen for Drizzle Nozzle - Part no. 13878
- 3 x String Nozzle 1/2" - Part no. 16593
- 3 x Cover Screen for Fog Nozzle - Part no. 13879

#### SOUND

Details see page 80



- 1 x Sound module MP3 - Part no. 18824-1
- 1 x Speaker - Part no. 14366-4
- 2 x Relais board WDT-NT-34 RSL-V2 - Part no. 24926

#### TO BE PROVIDED BY THE BUILDER

- Plants room for the installation of the control panel
- Power supply
- Water connection cold 1"
- Water connection warm 1"
- Needed pressure: 3 bar dynamic
- Water quantity: app. 60 l/min
- Drain in the plants room
- Tubing to the nozzles
- 2 x Non-return according to DIN EN 1717

#### ACCESSORIES / OPTIONS

- Optionally you can use Corian® or backlit ceiling element instead of PVC
- Fragrance



## SHOWER TUNNEL WITH CEILING ELEMENTS STAINLESS STEEL WITH 3 ZONES

### FUNCTION DESCRIPTION

In standby mode all zones are illuminated white. Once the tunnel has been activated the white light switches-off and only the currently activated zone is illuminated. The overlap time between the single zones is three seconds. The shower walk starts with a warm, aromatised Tropical Rain and red lights. You hear birds tweeting. In the following a warm Waterfall Full Blade is replacing the Tropical Rain. At the second station, a cold Rain is cooling the guest in the tunnel down, the illumination changes to blue. Afterwards a cold Fog replaces the cold Rain – you can hear the roll of thunder and flashlights fill the room. In the third zone a warm Tropical Rain patters together with a warm Waterfall Full Blade on the guest in the shower. The light shines red and birds tweeting. Afterwards the tunnel is ready for a restart.

### SCOPE OF DELIVERY OF A COMPLETE PACKAGE

#### CONTROL PANEL



Control panel incl. listed parts, pre-tubed, pre-wired and pre-mounted on PP board grey - Part no. 19374-1:

- 2 x Supply with pre-filter and ball valve MS 1" female thread
- Thermomixer JRG 3/4" with non-return valves
- 3 x Outlet with solenoid valve warm 3/4" and screwing 3/4"
- 2 x Outlet with solenoid valve cold 3/4" and screwing 3/4"
- 1 x Fragrance pump with fragrance reservoir and empty switch
- 1 x Dosing valve for the injection of aroma into the water tube
- 1 x Microprocessor controller EDS1 in housing

#### TECHNICAL DATA

Electrical supply	230 V-AC, 50 Hz
Power supply	150 W
Water supply	2 x 1" female thread
Dimensions (W/H/D)	1000 x 750 x 200 mm
Weight	app. 20 kg

#### PUSH BUTTON

Details see page 72

- 1 x Push-button plate 1-fold stainless steel polished - Part no. 25942
- 1 x Bonnet 1-fold - Part no. 21030-1

#### CEILING ELEMENT INCL. ILLUMINATION

Details see page 76

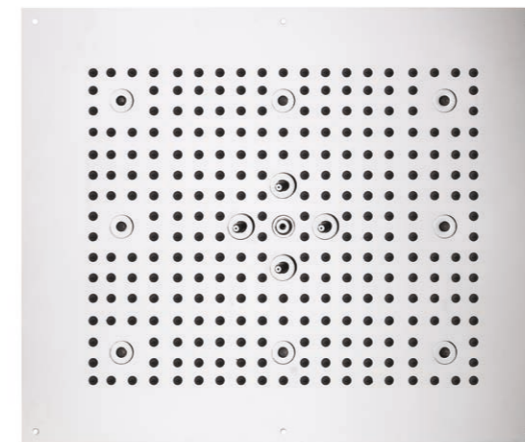

2 x Ceiling element stainless steel chrome optic (Rain Shower, Waterfall Full Blade - 4 LED RGB Spots) - Part no. 24652

1 x Ceiling element stainless steel chrome optic (Rain Shower, Mist - 8 LED RGB Spots) - Part no. 24980

#### SOUND

Details see page 80



- 1 x Sound module MP3 - Part no. 18824-1
- 1 x Speaker - Part no. 14366-4
- 2 x Relais board WDT-NT-34 RSL-V2 - Part no. 24926

#### TO BE PROVIDED BY THE BUILDER

- Plants room for the installation of the control panel
- Power supply
- Water connection cold 1"
- Water connection warm 1"
- Needed pressure: 3 bar dynamic
- Water quantity: app. 60 l/min
- Drain in the plants room
- Tubing to the nozzles
- 2 x Non-return according to DIN EN 1717

#### ACCESSORIES / OPTIONS

- Fragrance



SHOWER VISION –  
WATER IN THE NEXT DIMENSION



# SHOW ERDIME NSIONS



SHOWER VISION LIFTS  
THE SENSUAL EXPERIENCE  
INTO THE NEXT DIMENSION



**IMMERSE INTO THE FANTASTIC  
WORLD OF SHOWER VISION**  
Scan the QR-code oder search  
for "WDT Shower Vision" on youtube



## SHOWER VISION – VIDEO SYSTEM FOR EXPERIENCE SHOWERS

Smell, sight, hearing and touch: Experience Showers activate all the users' senses. Aromatised rain showers with light- and sound effects create the most pleasant dream worlds for the user.

ShowerVision lifts this sensual shower experience into another dimension. With the activation of a certain programme, a complementary video sequence starts simultaneously. During the Tropical Rain for example big, smooth water drops patter onto the guest in the shower. A fruity, lively aroma fills the air and the light in the shower changes from white to red. Additionally a video sequence, which gives the user the feeling to relax on a tropical beach starts on a screen.

The core of ShowerVision is a 75" Full-HD-monitor that is integrated in a waterproof bonnet and covered / sealed by a glass door. Different video sequences are pre-programmed.

ShowerVision is designed as a unique attraction for the luxury hotel and spa segment, as well as exclusive private homes.

## POSSIBLE PROGRAMME CONFIGURATION

### Stand-by

The shower is illuminated white and the sequence at the monitor gives the user the feeling to enjoy a sunset at the sea.

### Tropical Rain with aroma

After the start of the programme by a button, the light in the shower changes from white to red. A warm Tropical Rain with big, smooth drops patters onto the guest in the shower. A fruity, lively aroma fills the air. In a distance, you hear the sound of waves and sea. The visual effect of the ShowerVision gives the user the feeling to relax at a tropical beach. After the lapse of the programme, the illumination changes back to white and the sunset at the sea appears on the monitor again.

### Fog Shower

After the activation of the programme, the light in the shower changes from white to blue. A cold, refreshing fog with very fine droplets starts to spray. An alpine creek, which patters calmly over cold rocks, appears at the monitor out of nowhere. At the end of the programme, the illumination changes to white and the user returns to the sunset at the sea.

### Waterfall

The programme starts with a pleasant green illumination and two warm waterfalls that massage the body. The sequence at the monitor gives the user the feeling to stand under a roaring waterfall. After the lapse of the programme, the Stand-by mode is activated again.

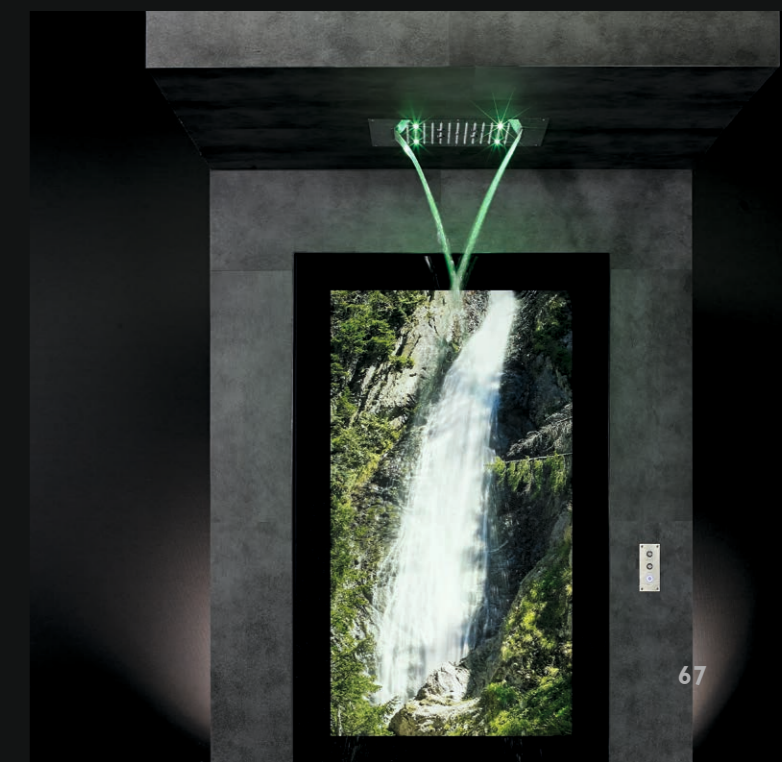





## SHOWERVISION SYSTEM CARIBBEAN STORM SED2

### SCOPE OF DELIVERY OF A COMPLETE PACKAGE

#### SHOWERVISION

Part no. 27444

- Aluminium installation housing, edged and welded, adapter for the monitor holder and glass panel, sealing flange for the in wall installation and four connections for active ventilation D 80 mm
- Glass panel, ESG safety glass 8 mm, on one side coated frame 125 mm, glued on aluminium support frame
- Heavy duty hinges and spring locks
- Telescopic slide-out for monitor
- LCD 75" Ultra-High Definition Large Format Display
- 4K Multimediaplayer, I/O Player

#### CONTROL PANEL

Part no. 14105

- 2 x Supply with pre-filter and ball valve MS 3/4" female thread
- Thermomixer JRG 3/4" with non-return valves
- 2 x Outlet with solenoid valve 1/2" and screwing 1/2"
- 1 x Outlet with solenoid valve 3/4" and screwing 3/4"
- Emptying for the tube to the aromatised nozzle
- Fragrance pump with fragrance reservoir and empty switch
- Dosing valve for the injection of aroma into the water tube
- Non-return according to DIN EN 1717
- Microprocessor controller EDS1 in housing
- Pre-tubed, pre-wired and pre-mounted on PP board grey

#### TECHNICAL DATA CONTROL PANEL

Electrical supply	230 V-AC, 50 Hz
Power supply	100 W
Water supply	2 x 3/4" female thread
Dimensions (W/H/D)	750 x 750 x 200 mm
Weight	app. 15 kg

#### PUSH BUTTON

Details see page 72

- 1 x Push-button plate 3-fold stainless steel polished - Part no. 25940
- 1 x Bonnet 3-fold - Part no. 21031-1

#### CEILING ELEMENT INCL. ILLUMINATION

Details see page 76

- 1 x Ceiling element stainless steel chrome optic (Rain Shower, Waterfall Full Blade, Waterfall Part Blade, Mist - 4 LED RGB Spots) - Part no. 24651

#### SOUND

Details see page 80

- 1 x Sound module MP3 - Part no. 18824-1
- 2 x Speaker - Part no. 28536

#### TO BE PROVIDED BY THE BUILDER

- Plants room for the installation of the control panel
- Stable recess in the wall
- Equalisation material (building boards) for the realisation of a flush installation with the final surface layer
- Connection to the central ventilation system
- Air exchange rate app. 25 m<sup>3</sup>/h
- Power supply 230 V
- Water connection cold 3/4"
- Water connection warm 3/4"
- Needed pressure: 3 bar dynamic
- Water quantity: app. 70 l/min
- Drain in the plants room
- Tubing to the nozzles

#### ACCESSORIES / OPTIONS

- Fragrance
- Air fans

#### TECHNICAL DATA TV-SYSTEM

##### Monitor

Dimensions (W/H/D)	959 x 1681 x 71 mm
Visible screen size (W/H)	927 x 1649 mm
Display size	75"
Resolution	2160 x 3840 px
Horizontal frequency	31,5 - 91,1 kHz
Vertical frequency	24,0 - 85,0 Hz (digital signal input)
Power supply	240 V, 50 - 60 Hz
Weight	app. 55 kg
Power consumption	195 W
Speaker output	External loudspeaker socket 15 W + 15 W (8 Ohm)
Operation environment	0 to +40 °C, 20 - 80 % (without condensation)
Operating time	24/7

##### Multimediaplayer

Dimensions (W/H/D)	159 x 144 x 22 mm
Weight	app. 375 g
Power supply internal	12 V-DC, Transformer 240 V, 50 - 60 Hz
Power consumption	18 W
Storage medium	Micro SD Card
Media formats	Video Codecs for 4K content: H.265/H.264, Video Containers for 4K H.265/H.264 content: .ts, .mov, .mp4 Video Codecs for Full HD: H.265, H.264 (MPEG-4, Part 10), MPEG-2, MPEG-1 Video Containers for Full HD: .ts, .mpg, .vob, .mov, .mp4, .m2ts Images: BMP, JPEG, PNG
Connecting Display	4K HDMI cable



##### Glass panel:

Dimensions (W/H)	1140 x 1880 mm
Material thickness	8 mm
Weight	app. 45 kg
Visible area (W/H)	880 x 1630 mm

##### Installation housing:

Dimensions (W/H/D)	1266 x 2006 x 215 mm
Material thickness	3 mm
Weight	app. 40 kg
Ventilation connections	selectable, 4 x D 80 mm





SYSTEM COMPONENTS

WITH SYSTEM  
LIGHT AUDIO  
NOZZLES BUTTONS





## PUSH BUTTON PLATES

### FUNCTION DESCRIPTION

#### Push button plates with piezo push buttons

- Available materials: Alu-Dibond, Stainless steel polished or brushed, Corian®
- Plates with 1 - 4 piezo buttons
- Recess for name plates, lasering or engraving (depending on material)
- Ready-made with plug or open wires for connection

### SCOPE OF DELIVERY

- Base plate (material see above)
- Piezo push-button(s) with or without illumination with
- 7 m connection cable / 4 screws M4 x 30
- Plug for the connection to WDT systems

### TECHNICAL DATA

	with illumination	without illumination
Switching function		N.O.
Electrical supply	12/24 V-DC	-
Switching voltage	24 V-AC/DC	
Switching current	max. 100 mA	
Power rating	1 W	
Dimensions 1-fold plate (W/H)	76 x 109 mm	
Dimensions 2-fold plate (W/H)	76 x 142 mm	
Dimensions 3-fold plate (W/H)	76 x 175 mm	
Dimensions 4-fold plate (W/H)	76 x 208 mm	

### TO BE PROVIDED BY THE BUILDER

- Empty conduit Ø 32 mm for the installation of the cable

### ACCESSORIES / OPTIONS

- Bonnet for in-wall mounting
- Further materials (gold-plated/bronze optique) on demand



Stainless steel polished      Stainless steel brushed



Alu-Dibond      Corian®  
Colours on request

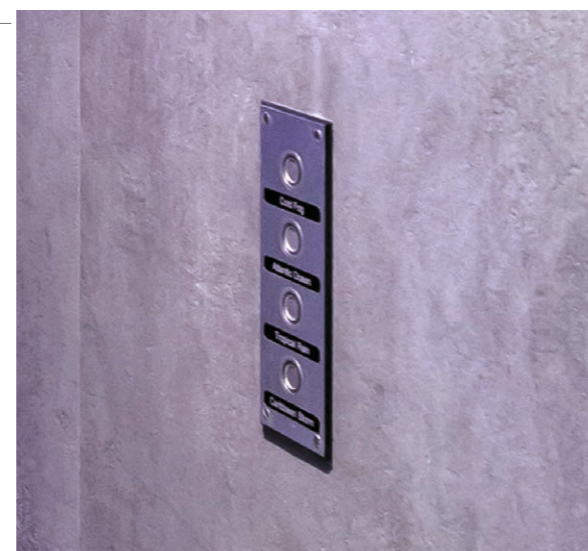

## BONNET/ BUILT-IN PART FOR IN-WALL MOUNTING OF PUSH BUTTON PLATES



### FUNCTION DESCRIPTION

Bonnets for in-wall mounting for the seal installation of WDT push button plates into construction boards or brick walls. Material Polystyrol (PS), black.

### SCOPE OF DELIVERY

- Built-in bonnet as described above incl. perforation for the connection of the empty conduit
- Protective cover made of EPS for the definition of a clear tile edge and for the protection against pollution of the inside

### TECHNICAL DATA

Bonnet 1-fold (W/H/D) Part no. 21030-1	96 x 129 x 52 mm
Bonnet 2-fold (W/H/D) Part no. 21034-1	96 x 162 x 52 mm
Bonnet 3-fold (W/H/D) Part no. 21031-1	96 x 195 x 52 mm
Bonnet 4-fold (W/H/D) Part no. 21032-1	96 x 228 x 52 mm

## NAMEPLATES FOR ALU-DIBOND PUSH BUTTON PLATES



### FUNCTION DESCRIPTION

For the labelling of the Alu-Dibond push button plates, we offer a big choice of nameplates. Beside our standard selection, we can manufacture your individual nameplate. Chinese or Russian nameplates are realisable too for example.

### SCOPE OF DELIVERY

Here a small selection of nameplates:

Part no.	Description
17528	Tropical Rain
17534	Cool Fog
18986	Side Nozzles
17527	Caribbean Storm
18596	Atlantic Ocean
17787	Kneipp





FOG NOZZLE

**FUNCTION DESCRIPTION**

Fog Nozzle for a very fine, cold fog

- Very pleasant cooling effect
- Wide spray angle
- Water saving

**SCOPE OF DELIVERY**

- Part no. 13526 - Fog Nozzle
- Connection 1/2" female thread
  - Brass, chrome plated
  - 130° spray angle
  - 6 l per minute at 5 bar
  - H 31 mm, Ø 40 mm

**ACCESSORIES / OPTIONS**

Cover screen Part no. 13877

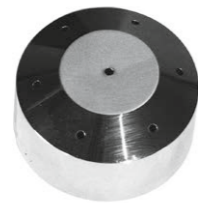

TROPICAL RAIN NOZZLE

**FUNCTION DESCRIPTION**

Tropical Rain Nozzle for big, smooth drops

- Ideal as warm shower
- For Tropical- or Gush Rain

**SCOPE OF DELIVERY**

- Part no. 13528 - Tropical Rain Nozzle
- Connection 1/2" female thread
  - Brass, chrome plated
  - 45° spray angle
  - 40 l per minute at 5 bar
  - H 31 mm, Ø 27mm

**ACCESSORIES / OPTIONS**

Cover screen Part no. 13879

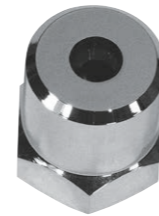

SPLASH NOZZLE

**FUNCTION DESCRIPTION**

Splash Nozzle for waterfall-/splash showers

- Big, smooth water wheel
- Ideal as cooling shower
- Water saving compared to normal splash sprinkler heads
- For installation at the wall or at the sealing

**SCOPE OF DELIVERY**

- Part no. 16363 - Splash Nozzle
- Connection 1/2" female thread
  - Brass, chrome plated
  - 45° spray angle
  - 22,5 l per minute at 2 bar

**ACCESSORIES / OPTIONS**

Cover screen Part no. 13879



WIDE JET NOZZLE

**FUNCTION DESCRIPTION**

Double-Wide jet nozzle

- Ideal for back massage
- Installation app. 1,20 - 1,40 m over floor level
- Ideal for water curtain effect or useful as side nozzle

**SCOPE OF DELIVERY**

- Part No. 16066 - Double-Wide jet nozzle
- Connection 1/2" female thread
  - Brass, chrome plated
  - 120° spray angle
  - 20 l per minute at 5 bar

**ACCESSORIES / OPTIONS**

Cover screen Part no. 13879



DRIZZLE NOZZLE

**FUNCTION DESCRIPTION**

Nozzle for a soft Drizzle Rain

- Ideal as warm shower
- For Country- or Summer Rain
- Water saving

**SCOPE OF DELIVERY**

- Part no. 13527 - Drizzle Nozzle
- Connection 1/2" female thread
  - Brass, chrome plated
  - 70° spray angle
  - 6 l per minute at 5 bar
  - H 28 mm, Ø 50 mm

**ACCESSORIES / OPTIONS**

Cover screen Part no. 13878



STRING NOZZLE

**FUNCTION DESCRIPTION**

String Nozzle for a warm, prickling rain

- Prickling on the skin, ideal as warm shower
- 15 single, fine water jets create a continuous string rain

**SCOPE OF DELIVERY**

- Part no. 16593 - String Nozzle
- Connection 1/2" female thread
  - Brass, chrome plated
  - 66° spray angle
  - 16 l per minute at 5 bar
  - H 31 mm, Ø 27 mm

**ACCESSORIES / OPTIONS**

Cover screen Part no. 13879

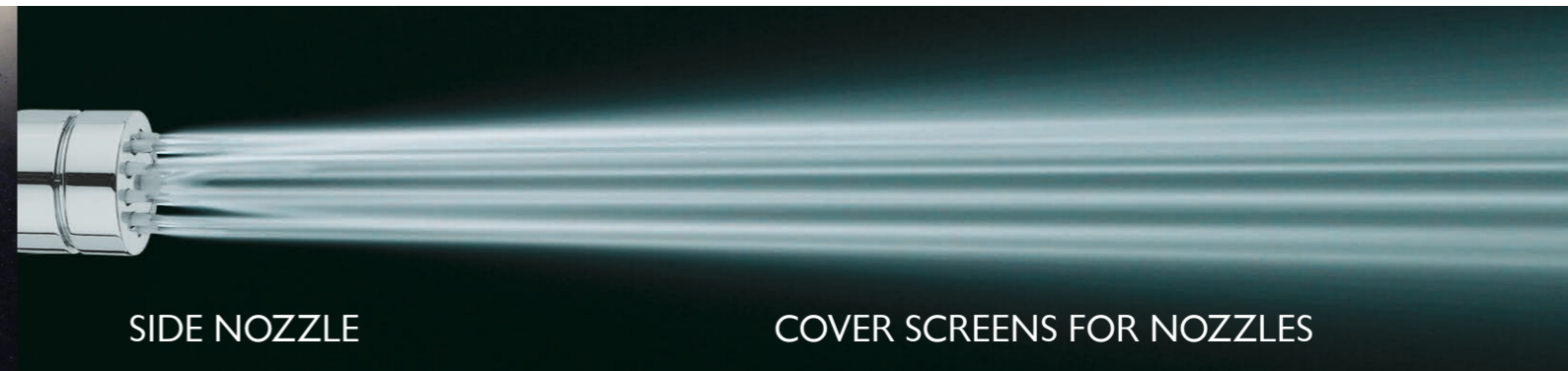

SIDE NOZZLE

**FUNCTION DESCRIPTION**

Side Nozzle for the installation in the wall

- Ideal as warm shower
- For Side Massage effect

**SCOPE OF DELIVERY**

- Part no. 19769-2 - Side Nozzle
- Connection 1/2" male thread
  - Chrome plated
  - 9 l per minute at 3 bar



COVER SCREENS FOR NOZZLES

**FUNCTION DESCRIPTION**

- Cover screens are available for the following nozzles: Fog, Tropical Rain, Drizzle, String, Splash, Wide Jet
- Available finishes: Plastic white, black or chrome-plated







## CEILING ELEMENT PVC



### FUNCTION DESCRIPTION

Ceiling element for Experience Showers made of PVC white with all necessary components integrated: Nozzles for water effects, loudspeaker for sound effects (optional) and LED spots RGB for the illumination of the shower.

### SCOPE OF DELIVERY

The ceiling elements Ø 800 x 19 mm consist of the following components:

- PVC plate Ø 800 mm
- 3 LED spots RGB - WDT POM Ø 48 mm - 350 mA
- Controller LED RGB - WDT SAU 350 mA with 7 m cable to the 1<sup>st</sup> spot
- Nozzle plates 2 x ½" - V2A - length 30 mm

### ACCESSORIES / OPTIONS

- Nozzles for Experience Showers (to be calculated separately, according to model)
- Loudspeaker
- Other dimensions and shapes on demand
- Fixation material

Part no.	Number of nozzle connections
21748-1	with 2 connections ½" for 2 nozzles
21767-2	with 3 connections ½" for 3 nozzles
21768-3	with 4 connections ½" for 4 nozzles
21769-3	with 5 connections ½" for 5 nozzles
21770-1	with 6 connections ½" for 6 nozzles
21771-1	with 7 connections ½" for 7 nozzles
22066-1	with 8 connections ½" for 8 nozzles
21830-1	with 9 connections ½" for 9 nozzles
21772-1	with 11 connections ½" for 11 nozzles

## CEILING ELEMENT BACKLIT



### FUNCTION DESCRIPTION

Backlit ceiling element for Experience Showers with all necessary components integrated: Nozzles for the water effects and LED strips for the illumination of the shower. The LED strips are installed on the backside of Plexiglas disc. This indirect illumination illuminates the complete ceiling element, which creates unique light effects.

### SCOPE OF DELIVERY

The ceiling elements Ø 800 x 100 mm consist of the following components:

- Light bonnet Polystyrol Ø 760 x 100 mm
- Plexiglas-disc 8 mm round Ø 800 mm
- Strip lights LED RGB - WDT - 24 VDC
- Controller LED RGB - WDT - SAU-Linelight - 24 V-DC with 7 m cable to the strip lights
- Nozzle plates 2 x ½" - V2A - length 150 mm

### ACCESSORIES / OPTIONS

- Nozzles for Experience Showers (to be calculated separately, according to model)
- Loudspeaker (to be installed in suspended ceiling)
- Other dimensions and shapes on demand
- Fixation material

Part no.	Number of nozzle connections
21117-1	with 2 connections ½" for 2 nozzles
21118-1	with 3 connections ½" for 3 nozzles
21119-1	with 4 connections ½" for 4 nozzles
21120-1	with 5 connections ½" for 5 nozzles
21121-1	with 6 connections ½" for 6 nozzles
21122-1	with 7 connections ½" for 7 nozzles
21164-1	with 8 connections ½" for 8 nozzles
21392-1	with 10 connections ½" for 10 nozzles
21167-1	with 11 connections ½" for 11 nozzles

## CEILING ELEMENT CORIAN®



### FUNCTION DESCRIPTION

Ceiling element for Experience Showers made of Corian® with all necessary components integrated: Nozzles for water effects, loudspeaker for sound effects (optional) and LED spots RGB for the illumination of the shower.

### SCOPE OF DELIVERY

The ceiling elements Ø 800 x 12 mm consist of the following components:

- Corian® plate Ø 800 mm – colours on demand
- 3 LED spots RGB - WDT MS chromed Ø 60 mm - 350 mA
- Controller LED RGB - WDT SAU 350 mA with 7 m cable to the 1<sup>st</sup> spot
- Nozzle plates 2 x ½" - V2A - length 30 mm

### ACCESSORIES / OPTIONS

- Nozzles for Experience Showers (to be calculated separately, according to model)
- Loudspeaker
- Other dimensions and shapes on demand
- Fixation material

Part numbers according to the chosen colour and number of nozzles.







## CEILING ELEMENT STAINLESS STEEL CHROME OPTIC

### FUNCTION DESCRIPTION

Ceiling element for Experience Showers made of stainless steel in chrome optic with all necessary components integrated: Nozzles / shower heads for water effects and LED spots RGB for the illumination of the shower. Equipped for max. four attractions that are controlled from an Experience Shower control panel.

### SCOPE OF DELIVERY

The elements consist of the following components:

- Ceiling element stainless steel, chrome optic
- Nozzles and head shower elements
- 4 (8) LED spots RGB - WDT - 700 mA
- Controller LED RGB - WDT SAU 700 mA with 7 m cable to the 1<sup>st</sup> spot
- Supply hoses
- Fixation material

### ACCESSORIES / OPTIONS

- Loudspeaker (to be installed in suspended ceiling)
- Other dimensions and shapes on demand

### TECHNICAL DATA

Dimensions	570 x 470 mm
Water connection	2 or 4 x 1/2" (according to version)
Flow rates of the single attractions at app. 3 bar:	
Rain Shower	app. 30 l/min
Mist	app. 10 l/min
Waterfall Full Blade	app. 20 l/min
Waterfall Part Blade	app. 19 l/min
Weight	app. 12 kg

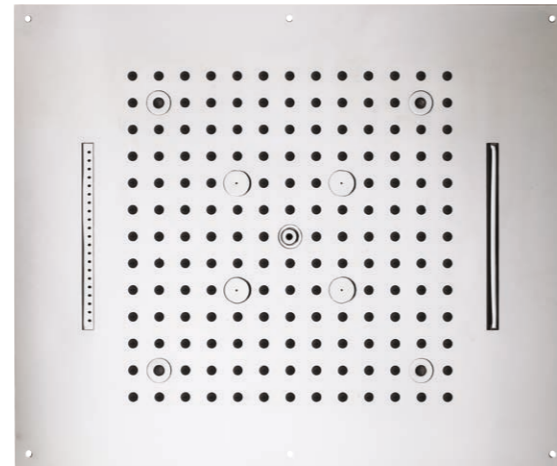

Example photo Part-no. 24651

### POSSIBLE CONFIGURATIONS

**Part no. 24980:**  
Rain Shower, Mist (8 LED RGB Spots)



**Part no. 24652:**  
Rain Shower, Waterfall Full Blade (4 RGB Spots)



**Part no. 24651:**  
Rain Shower, Waterfall Full Blade, Waterfall Part Blade, Mist (4 RGB Spots)

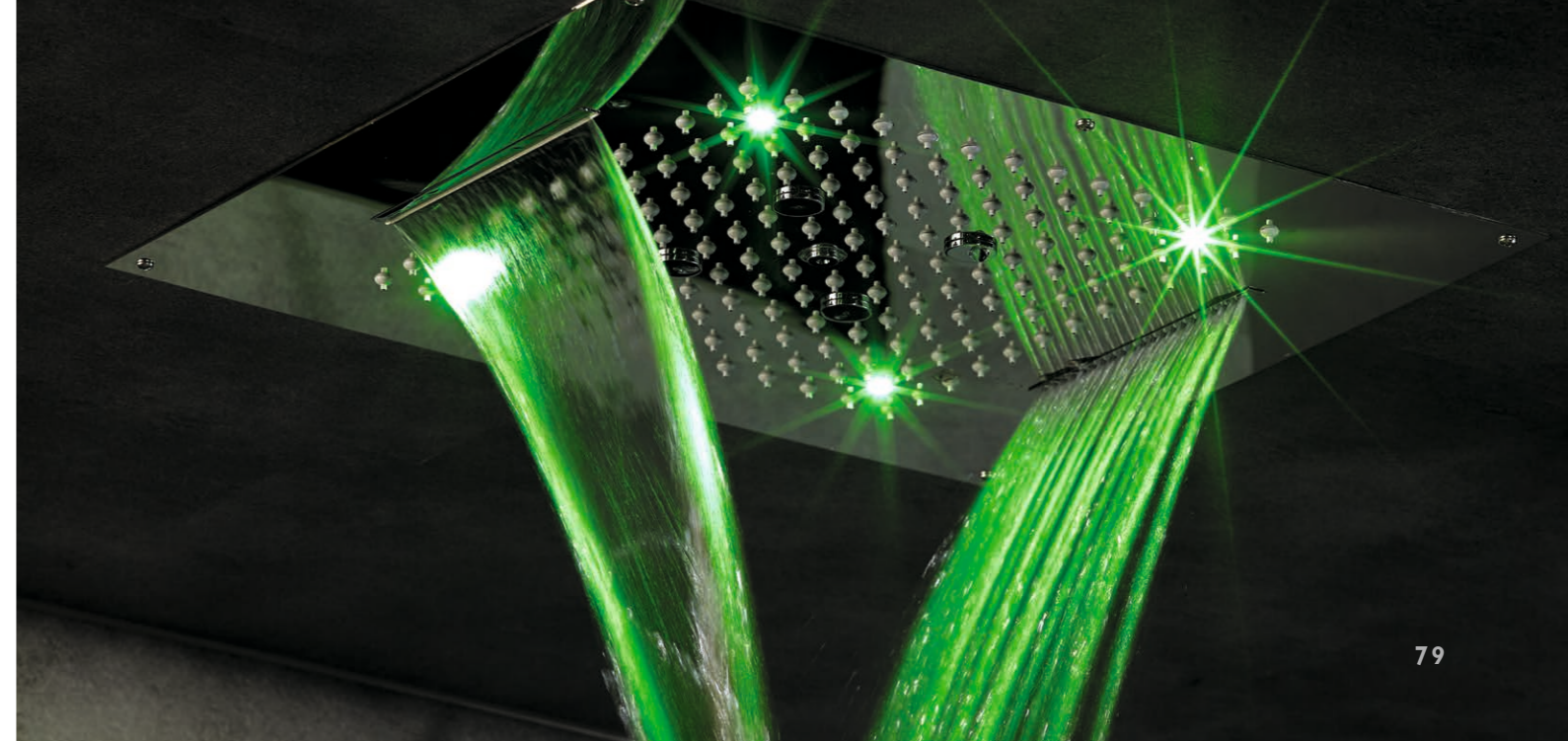
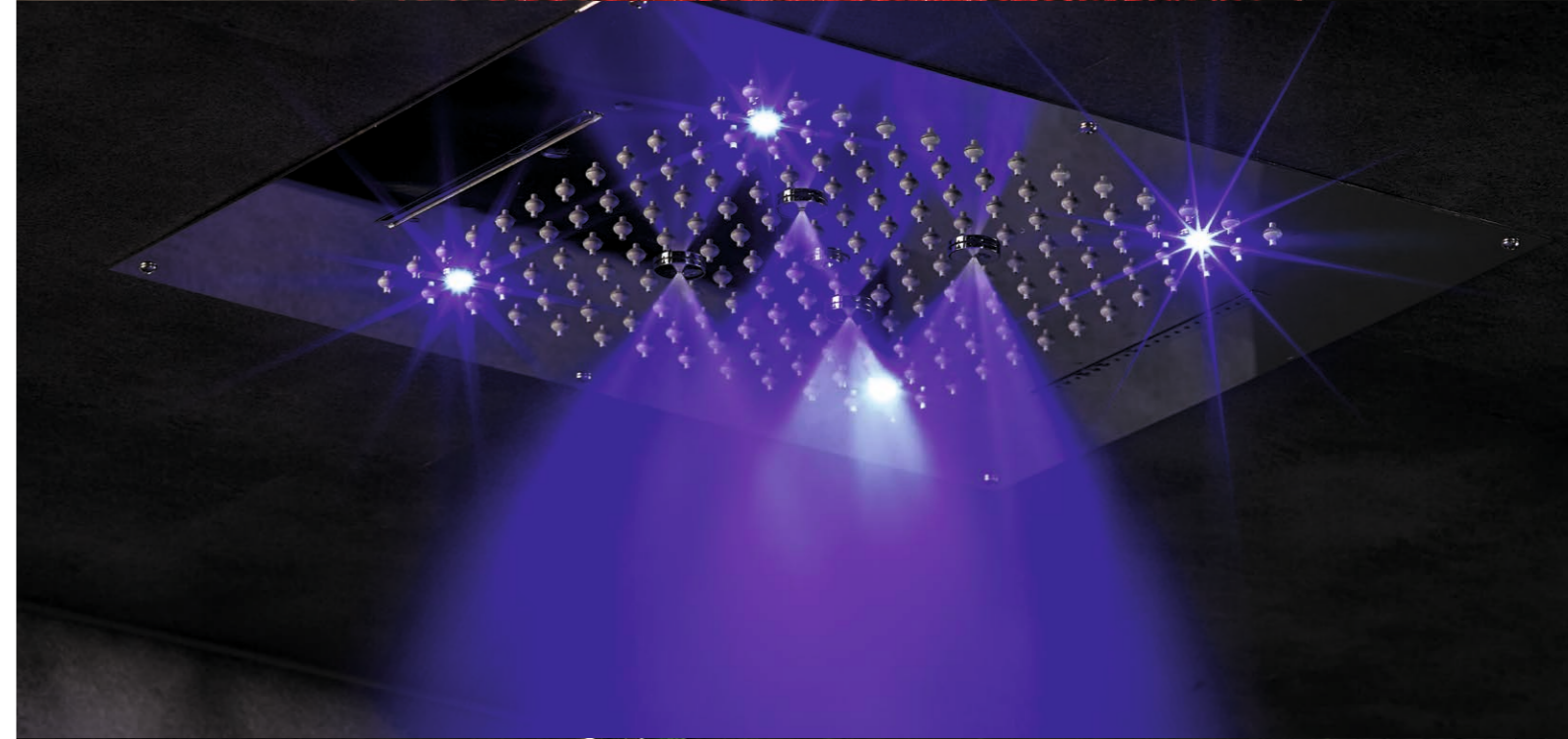
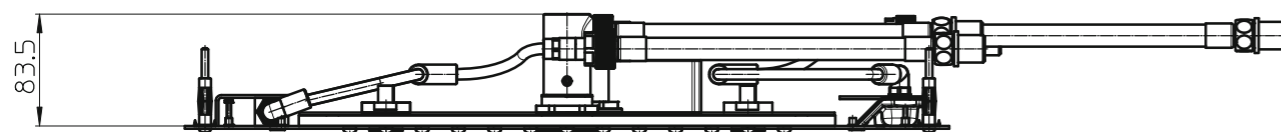





## SOUND MODULE

### FUNCTION DESCRIPTION

MP3-player with integrated amplifier built into a compact housing for cap rail installation. The system can play MP3 sound files from a USB stick or a micro SD card. The music can also be transmitted via a Line in/Line out-connection and emitted via integrated stereo amplifier. It is possible to control certain titles separately or to play them within a playlist. The system can manage up to four playlists.

The system can be controlled via RS485-interface with a Mod-Bus protocol. Furthermore, it is possible to control playlists or titles directly via four digital inputs. Additionally there are four further digital inputs, to operate the player: play, stop, next and back. The volume up and down functions are realised by longer signals on the play and stop inputs.

The MP3-player can easily be operated directly on the device via a five-line LC display and three capacitive buttons.

### SCOPE OF DELIVERY

- MP3-Player
- Micro SD card 8 GB (min. speed class 4)

#### Interfaces:

- USB
- Micro SD card
- Line in / out
- 2-wire data BUS MOD BUS RTU 485
- 4 digital inputs for binary code
- 4 digital inputs for keyboard

### ACCESSORIES / OPTIONS

- Loudspeaker
- Transformer
- Relay board WDT NT34 for control with 230 V signals

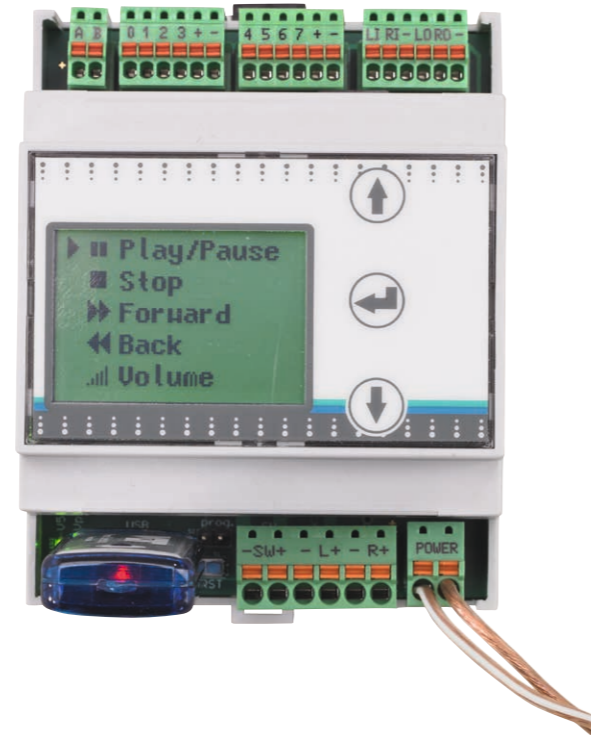

### TECHNICAL DATA

Electrical supply	12 - 24 V-DC 12 - 18 V-AC
Power supply	10 W
Weight	300 g
Dimensions (W/H/D)	71 x 90 x 58 mm
Music output	2 x 25 W 4 Ohm Stereo + 20 W 4 Ohm Subwoofer (at power supply 24 V-DC or 18 V-AC)
Protection class	IP30
Temperature range	0 to +40 °C
Accepted formats	.mp3

## HUMIDOR LOUDSPEAKER

### FUNCTION DESCRIPTION

Sea water resistant broadband speaker 10 cm (4") with plastic membrane and plastic basket/-grill incl. resonance bonnet. Resistant against humidity and corrosion. Clear playback of high tones. Colour white.

#### Anwendungsmöglichkeiten:

- Showers
- Outdoors
- Boats, ships and open vehicles

#### Characteristics:

- Sea water resistant
- Useful for low temperatures according to EN 60068-2-1 (-40 °C; 96 h)
- Plastic: ASA (UL 94: HB; UV-resistant)
- Complies with the requirements of the "German Lloyd"



### TECHNICAL DATA

Nominal power handling	20 W
Capacitance	30 W
Impedency	4 Ohm
Frequency response	(-10 dB) 80 - 16000 Hz
Acoustic pressure	85 dB(A)
Angle (-6 dB)	76° / 4000 Hz
Protection class	IP65
Temperature range	-40 to +80 °C
Colour	white
Weight	0,275 kg





## TECHNIQUE FOR STEAM ROOMS

A pleasant aroma and the perfect room climate are key factors for optimum pleasure in a steam room! We see ourselves as a one-stop provider of technical equipment for steam rooms. Furthermore, WDT has acquired extensive knowledge about the construction and technical configuration of steam rooms.

- 84 Dosing of fragrances for steam rooms - DUFTDOS
- 89 Steam impact
- 90 LED illumination
- 96 Steam generators
- 98 Technique for Healing Clay Steam Bath
- 100 Accessories for steam rooms
- 102 Moduleconcept**

# PLEASURE



## BODY AND SOUL IN BALANCE

- » Technical single-source systems for private and public steam rooms
- » High grade of flexibility through modular conception
- » Designed to allow individual, customised solutions
- » On demand all technical components for steam rooms can be offered pre-mounted and pre-wired on mounting boards. This guarantees an easy, quick and trouble-free installation

**We consult you with pleasure about detailed configuration possibilities**



## DUFTDOS-0-COMPACT

### FUNCTION DESCRIPTION

Peristaltic dosing pump for the dosing of fragrances into the steam pipe of steam rooms. For external control with 230 V-AC e.g. by the steam generator or by an external controller. The control signal must be interlocked with the steam production.

### SCOPE OF DELIVERY

- Peristaltic pump SA app. 3 l/h
- Dosing hose 3,2 x 1,6 Viton with hose holder
- Roller SA yellow
- Connection cable 3 x 0,75<sup>2</sup>
- Suction hose PE 4 x 1 - 1,5 m

### TECHNICAL DATA

Electrical supply	230 V-AC, 50 Hz
Power supply	6 W
Back pressure max.	app. 0,5 bar
Dimensions (W/H/D)	65 x 140 x 85 mm
Weight	app. 0,6 kg

### ACCESSORIES / OPTIONS

- Console with bottle 1,5 l - Part no. 13892
- Console for 10 l canister - Part no. 14391
- Dosing set consisting of: dosing valve stainless steel 3/8" - 4 x 1 and 3 m dosing tube PTFE 4 x 1 - Part no. 12596



Photo: with option console with bottle 1,5 l

## DUFTDOS-0-T

### FUNCTION DESCRIPTION

Peristaltic dosing pump for the dosing of fragrances into the steam pipe of steam rooms. For external control with 230 V-AC e.g. by the steam generator or by an external controller. The control signal must be interlocked with the steam production. With tests switch for priming and test function.

### SCOPE OF DELIVERY

- Peristaltic pump SA app. 3 l/h
- Dosing hose 3,2 x 1,6 Viton with hose holder
- Roller SA yellow
- Connection cable 3 x 0,75<sup>2</sup>
- Suction hose PE 4 x 1 - 1,5 m
- Test button

### TECHNICAL DATA

Electrical supply	230 V-AC, 50 Hz
Power supply	6 W
Back pressure max.	app. 0,5 bar
Dimensions (W/H/D)	80 x 180 x 140 mm
Weight	app. 0,6 kg

### ACCESSORIES / OPTIONS

- Console with bottle 1,5 l - Part no. 13892
- Console for 10 l canister - Part no. 14391
- Dosing set consisting of: dosing valve stainless steel 3/8" - 4 x 1 and 3 m dosing tube PTFE 4 x 1 - Part no. 12596

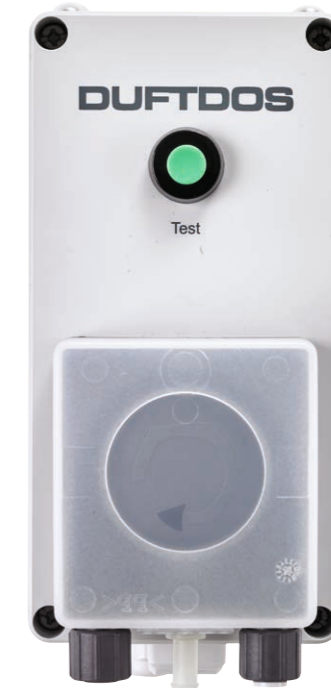



## DUFTDOS-DS

### FUNCTION DESCRIPTION

Peristaltic dosing pump for the dosing of fragrances into the steam pipe of steam rooms with intensity controller.

The dosing performance is adjusted by the pause time in between the injections by a rotary knob at the housing. The dosing time is set inside the housing. Dosing performance max. 3 l/h. Optionally the pump can be controlled by a push button from the steam room or by a non-volt contact.

### SCOPE OF DELIVERY

- Controller DS with rotary knob, installed in housing
- Peristaltic pump SA app. 3 l/h
- Dosing hose 3,2 x 1,6 Viton with hose holder
- Roller SA yellow
- Power supply cable with Euro plug
- Suction hose PE 4 x 1 - 1,5 m

### TECHNICAL DATA

Electrical supply	230 V-AC, 50 Hz
Power supply	6 W
Back pressure max.	app. 0,5 bar
Dimensions (W/H/D)	80 x 180 x 140 mm
Weight	app. 0,6 kg

### ACCESSORIES / OPTIONS

- Console with bottle 1,5 l - Part no. 13892
- Console for 10 l canister - Part no. 14391
- Dosing set consisting of: dosing valve stainless steel 3/8" - 4 x 1 and 3 m dosing tube PTFE 4 x 1 - Part no. 12596



## DUFTDOS VARIO 4 W-UNPL COMPACT

### FUNCTION DESCRIPTION

Dosing system for the dosing of several fragrances into the steam pipe of steam rooms. The desired aroma is chosen by a pre-selector switch at the controller of the unit by the operator. After the setting of the aroma it is dosed in adjustable intervals. The dosing performance is controlled by the pause- and dosing times by rotary knobs at the housing.

### SCOPE OF DELIVERY

- Controller UNPL for pause- and dosing times, installed in housing
- 4 x Peristaltic pump SA app. 3 l/h with 4 x dosing hose 3,2 x 1,6 Viton with hose holder and 4 x suction hose PE 4 x 1 - 1,5 m
- 4 x Bottle à 1,5 l
- 4 x 3 m dosing tube PTFE 4 x 1
- Console with the components pre-installed
- 4 x dosing valve stainless steel 3/8" - 4 x 1



### TECHNICAL DATA

Electrical supply	230 V-AC, 50 Hz
Power supply	6 W
Back pressure max.	app. 0,5 bar
Dimensions (W/H/D)	600 x 500 x 200 mm
Weight	app. 5 kg

### ACCESSORIES / OPTIONS

- Available for 2 or 3 aromas (on demand)





## DUFTDOS VARIO 4 T-SA COMPACT

### FUNCTION DESCRIPTION

Dosing system for the dosing of several fragrances into the steam pipe of steam rooms. The desired aroma is chosen by the user of the steam room by a push-button. The aroma intensity can be set individually for each aroma at the controller. During the dosing of the desired aroma, the other aroma pumps are locked. After the lapse of the programme the dosing is locked for three minutes.

### SCOPE OF DELIVERY

- Controller EDS1 installed in housing
- 4 x Peristaltic pump SA app. 3 l/h with 4 x dosing hose 3,2 x 1,6 Viton with hose holder and 4 x suction hose PE 4 x 1 - 1,5 m
- 4 x Bottle à 1,5 l
- 4 x 3 m dosing tube PTFE 4 x 1
- Console with the components pre-installed
- 4 x dosing valve stainless steel 3/8" - 4 x 1



### TECHNICAL DATA

Electrical supply	230 V-AC, 50 Hz
Power supply	10 W
Back pressure max.	app. 0,5 bar
Dimensions (W/H/D)	600 x 500 x 200 mm
Weight	app. 5 kg

### ACCESSORIES / OPTIONS

- Available for 2 or 3 aromas (on demand)
- Push button plate with bonnet for in-wall mounting



## STEAM IMPACT

### FUNCTION DESCRIPTION

The Steam Impact is a unique experience for steam rooms. This "air shower" blows compressed air into the steam room through nozzles. The air nozzles are installed in the ceiling of the cabinet directly over the seats. After the start of the attraction, the hot air layers from the top of the steam room stream down onto the guests below. For the bather the effect feels like a sauna splash and offers a unique experience. The Steam Impact consists of a pneumatic controller, an oil-free compressor with an expansion tank, buttons and nozzles.

### SCOPE OF DELIVERY

A complete package for a Steam Impact consists of the following components:

#### Electronic and pneumatic control panel consisting of:

- Controller CB36 with LC Display installed in housing
- Power socket for the connection of the compressor
- Completely tubed and pre-wired on PP board grey
- Ball valve 1/2"
- Pneumatic pressure gauge with water separator
- Connection compressed air-buffer tank
- Connection compressed air-compressor
- Solenoid valve(s) complying with the number of nozzles/seats

#### Stainless steel pressure tank

- 20 l with diaphragm, pre-mounted on the backside of the PP board
- Weight 5,5 kg

#### Oil-free compressor

- 230 V, 50 Hz (60 Hz),
- Performance 49 l/min at 5 bar
- Drive power 0,45 kW, pressure tank 10 l
- Control valve 1/8" - NO
- Dimensions W x L x H: 360 x 390 x 420 mm
- Weight: 17 kg
- Sound emission: 58 dB(A)

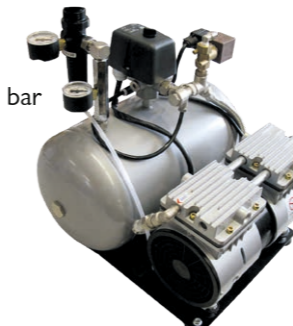

#### Push button plate(s) 1 fold

- With bonnet for in-wall mounting and name plate for the start of the programme (quantity complies with the number of nozzles/seats)

#### Drizzle Nozzle(s)

- Quantity complies with the number of nozzles/seats



Photo: Control panel 4 fold for 4 seats

### TECHNICAL DATA

Electrical supply	230 V-AC, 50 Hz
Power supply	550 W (incl. 450 W compressor)

#### Control panel 1 and 2 fold

Dimensions (W/H/D)	500 x 500 x 450 mm
Weight	app. 7,5 kg

#### Control panel 3 and 4 fold

Dimensions (W/H/D)	650 x 500 x 450 mm
Weight	app. 9,5 kg

### TO BE PROVIDED BY THE BUILDER

- Plants room for the installation of the control panel
- Power socket 230 V, 50 Hz
- Air tubes to the nozzles (according to the no. of seats in the cabinet)
- Temperature range in plants room: +5 to +40 °C
- Humidity in plants room: max. 80 % rel. humidity
- Due to the noise emission of the compressor we recommend to provide a noise damping installation







## LED SPOTS AND MOUNTING SLEEVES

### FUNCTION DESCRIPTION

The spots have especially been developed for the use in Wellness areas and steam rooms. The spots have the protection class is IP67 and they are operated with low voltage. Furthermore, the spotlights can be exchanged easily when they are already installed and sealed in. The spots are available in LED RGB, RGBW or warm white. As the spots are prepared with plug ready to use, an easy and trouble free installation is ensured.

### SCOPE OF DELIVERY

#### System for pre-coated, GFK or Aluminum surfaces:

- LED spots RGB, RGW or warm white IP67 brass chrome plated, stainless steel or aluminium coated (colour on demand), lense beamless
- Installation boring 42 mm
- Cover 60 mm outer diameter
- Mounting sleeve D 42 x 110 (40) mm with counter nut
- Incl. connection cable 20 cm JST

#### Systems for tiled surfaces:

- LED spots RGB, RGW or warm white IP67 brass chrome plated, stainless steel or aluminium coated (colour on demand), lense beamless
- Installation boring 42 mm
- Cover 60 mm outer diameter
- Mounting sleeve D 42 x 110 (40) mm with sealing flange
- Incl. connection cable 20 cm JST

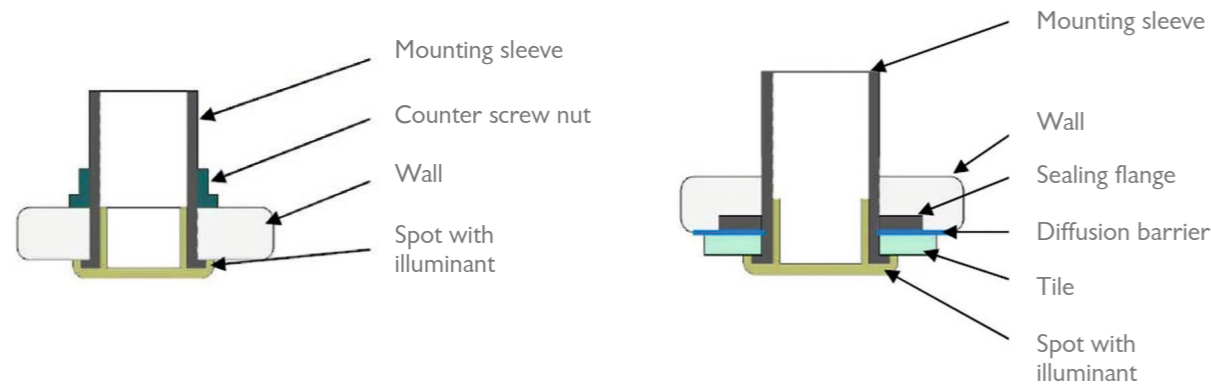

### TECHNICAL DATA

	RGB	RGBW	Warm White
Control signal	350 mA constant current		
Power supply	3 x 1 W	4 x 1 W	1 W
Light colour	Red/Green/Blue	Red/Green/Blue/Warm White	Warm White 2700 K
Installation boring	42 mm		
Weight	app. 0,25 kg		
Installation depth	55 mm or 125 mm (depending on the mounting sleeve)		
Diameter of the cover	60 mm		
Protection class	IP67		

### ACCESSORIES / OPTIONS

- The spots are connected in series. For the connection of the single spots there are extension cables available: 1,5 - 2,5 - 5,0 - 7,0 - 15,0 m
- Available for control signal 700 mA constant current

## CONTROLLER FOR LED SPOTS RGB / RGBW

### FUNCTION DESCRIPTION

Controller for LED spots RGB or RGBW with an operation current of 350 mA. You can connect up to 10 pieces of RGB or RGBW spots to one controller. The controller can realise six (respectively seven at RGBW) static light colours and nine (respectively eight at RGBW) light programmes. The different light programmes are set by a code switch at the housing. Optionally the light programmes can be controlled externally by a four-digit digital code. The connected spotlights can be dimmed by a second poti at the control housing.

If more than 10 spots are required the controllers can be extended by Slave modules.

### SCOPE OF DELIVERY

- LED RGB or RGBW control board installed in housing
- Code switch for the setting of the desired light programme
- Poti for the manual dimming of the connected spotlights
- 7 m cable from the controller to the 1<sup>st</sup> spot
- 1,5 m power supply cable with Euro plug

### TECHNICAL DATA

	RGB	RGBW
Electrical supply	230 V-AC, 50 - 60 Hz	
Power supply	42 VA	
Temperature range	0 to +50 °C	
Weight	1,5 kg	2,7 kg
Dimensions (W/H/D)	130 x 180 x 90 mm	200 x 250 x 120 mm

### ACCESSORIES / OPTIONS

- Available with operation- / constant current 700 mA
- Slave controller for external control / colour choice by a 4 digit HEX Code



Example photo: RGBW controller without code switch and without dim poti





## TRANSFORMER FOR LED SPOTS WARM WHITE

### FUNCTION DESCRIPTION

Transformer for LED spots warm white with an operation current of 350 mA. You can connect up to 6 pieces of 1 W spots to one transformer (to dimmable transformer up to 15 spots). The connected spotlights can be dimmed by a poti at the control housing or by external 1 - 10 V dimming signal.

If more than 6 respectively 15 spots are required, a second light circuit has to be installed.



### TECHNICAL DATA

	Dimmable transformer	Non-dimmable transformer
Electrical supply	230 V-AC, 50 - 60 Hz	
Power supply	42 VA	9 VA
Temperature range	0 to +50 °C	
Weight	1,2 kg	0,46 kg
Dimensions (W/H/D)	130 x 230 x 110 mm	100 x 80 x 65 mm

### SCOPE OF DELIVERY

- Transformer installed in housing
- Poti for the manual dimming of the connected spotlights (at option dimmable transformer)
- 7 m cable from the controller to the 1<sup>st</sup> spot
- 1,5 m power supply cable with Euro plug

### ACCESSORIES / OPTIONS

- Available with operation- / constant current 700 mA



## LINELIGHT HELLIFLEX MIDI

### FUNCTION DESCRIPTION

Flexible LED strip with an operation voltage of 24 V-DC, available in LED RGB, RGBW or warm white. The strip can be either installed with holding brackets (e.g. if installed in wooden cabinets) or with a mounting profile (e.g. if installed under the benches of steam rooms). The Helliflex system is prepared with a double-sided adhesive tape on the backside and available in different standard lengths. The lengths is adaptable on site. Therefore, a protection cap made of transparent silicon is included in the scope of delivery.



### SCOPE OF DELIVERY

- LED light strip, casted in 2-components resin with 4 m cable and AMP plug
- Protection cap for adaption of the length on site

### TECHNICAL DATA

	RGB	RGBW	Warm White
Control signal	24 V-DC RGB - / com +	24 V-DC RGB - / com +	24 V-DC
Light colour	Red/Green/Blue	Red/Green/Blue/Warm White	Warm White 2700 K
Dimensions (W/H/L)	13 x 5 mm x length	15 x 5 mm x length	11 x 5 mm x length
Temperature range	-20 to +60 °C		
Protection class	IP68		

### ACCESSORIES / OPTIONS

- Recommendation:  
Aluminium installation profile 17 x 5 mm - available in pieces of 2 or 3 m
- Holding brackets for Helliflex-Midi





## LINELIGHT / LIGHT RAILS

### FUNCTION DESCRIPTION

LED linelights with an operation voltage of 12 V-DC, available in LED RGB or warm white. Ideal for indirect illumination or illumination under the benches of steam rooms in casted version with 12 x 12 mm Aluminium profile. The Linelights are produced to order in the desired lengths.

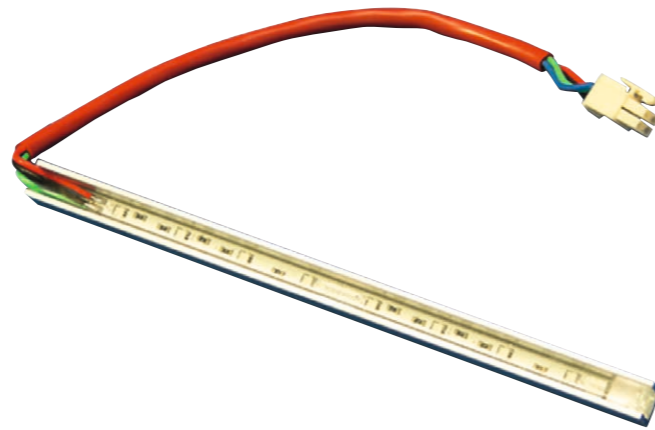

### SCOPE OF DELIVERY

#### LED- Linelight Aluprofile IP65

- Equipped with SMD- LEDs, cased with transparent 2-component resin
- Incl. connection cable and plug
- Available lengths from 119 mm up to 3000 mm

### TECHNICAL DATA

	RGB	Warm White
Control signal	12 V-DC RGB - / com+	12 V-DC
Light colour	Red/Green/Blue	Warm White 2700 K
Dimensions (W/H/L)	12 x 12 mm x length	
Temperature range	-20 to +60 °C max.	
Protection class	IP65	

### ACCESSORIES / OPTIONS

- Extension cables incl. connector
- Y-cable 4-poles incl. connector



## CONTROLLER FOR LED LINELIGHTS RGB / RGBW

### FUNCTION DESCRIPTION

Controller for LED Linelights RGB or RGBW with an operation voltage of 12 V-DC. You can connect up to 105 W of RGB- or 180 W of RGBW linelights to one controller. The controller can realise six (respectively seven at RGBW) static light colours and nine (respectively eight at RGBW) light programmes. The different light programmes are set by a code switch at the housing. Optionally the light programmes can be controlled externally by a four-digit digital code. The connected lights can be dimmed by a second poti at the control housing.

If more than 105 W RGB respectively 180 W RGBW are required the controllers can be extended by Slave modules.

### SCOPE OF DELIVERY

- LED RGB or RGBW control board installed in housing
- Code switch for the setting of the desired light programme
- Poti for the manual dimming of the connected spotlights
- 1,5 m power supply cable with Euro plug

### TECHNICAL DATA

	RGB	RGBW
Electrical supply	230 V-AC, 50 - 60 Hz	
Power supply	150 VA	180 VA
Temperature range	0 to +50 °C	
Weight	2,8 kg	2,7 kg
Dimensions (W/H/D)	260 x 220 x 110 mm	200 x 250 x 120 mm

### ACCESSORIES / OPTIONS

- Available with operation voltage 24 V-DC
- Transformer for warm white
- Slave controller for external control / colour choice by a 4 digit HEX Code



Example photo: RGBW controller without code switch and without dim poti





## STEAM GENERATORS FLEXLINE

### FUNCTION DESCRIPTION

The FlexLine represents a new generation of steam generators which consists of a basic model that can be expanded to create an individual solution suitable for all steam requirements. In order to make this flexibility available to our customers quickly, we have developed a modular system. FlexLine is available as an electrode as well as a heater element steam generator – depending on your water quality and the required degree of control accuracy.

### SCOPE OF DELIVERY

#### Large surface electrodes

Electrode steam generators are an optimal solution when simple and reliable steam production is required. Due to the high amount of material, the solid full-surface electrodes are particularly durable and are very well suited for the use of tap water. The electrodes have to be exchanged less often, which keeps the maintenance costs relatively low. When using steam generators that work with electrodes the electrical conductivity of the water in the supply has to be between 250 - 800  $\mu\text{S}/\text{cm}$  to ensure an optimal function.

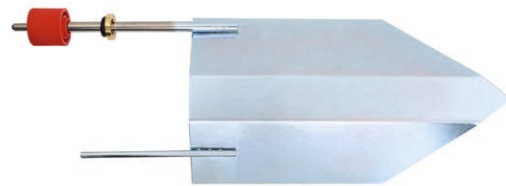

#### Resistor type heater elements

Steam cylinders with resistance heater elements made of highly corrosive-resistant alloy are suitable for a wide variety of water qualities, especially for treated water. They offer an extremely high level of control accuracy and ensure a virtually continuous and maintenance-free operation.



#### Excellent ease of operation

All FlexLine units are equipped with a capacitive 3.5" touch screen whereby operation and programming is selected via a flat and intuitive menu structure analogous to modern smartphone logic. In addition to this, subsequent software updates are quickly and easily possible via USB stick.

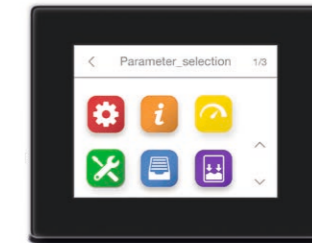

### TECHNICAL DATA FLEXLINE WITH ELECTRODES

Type		FLE05	FLE10	FLE15	FLE20	FLE25	FLE30	FLE40	FLE50	FLE65	FLE80	FLE100	FLE130
Steam output	[kg/h]	4,8-5,2	9,5-10,4	14,3-15,6	19,0-20,8	24,0-26,0	28,5-31,2	38,2-41,7	48,0-52,0	62,0-67,5	76,4-83,4	95,5-104,4	124,0-135,0
Electrical connection *		380-415 V / 3 Ph / 50-60 Hz											
Rated power	[kW]	3,6-3,9	7,1-7,8	10,8-11,7	14,3-15,6	18,0-19,5	21,4-23,4	28,6-31,2	35,9-39,2	46,3-50,6	2 x 28,6-31,2	2 x 35,9-39,2	2 x 46,3-50,6
Rated current	[A]	5,4	10,8	16,3	21,7	27,2	32,5	43,5	54,5	70,4	2 x 43,5	2 x 54,5	2 x 70,4
Fuse **	[A]	3 x 10	3 x 16	3 x 40	3 x 40	3 x 40	3 x 40	3 x 50	3 x 63	3 x 80	2 x 3 x 50	2 x 3 x 63	2 x 3 x 80
Control voltage		220-240 V / N / 2,5 A											
Steam hose connection	[mm]	1 x 40			2 x 40 mit Y			2 x 40		2 x 40 mit Y		4 x 40	
Unit size ***	Height [mm]	535		695		750		785		750		785	
	Width [mm]	540		540		580		640		1130		1170	
	Depth [mm]	320		320		355		420		420		420	
Water installation		Tap water of varying qualities, 1 - 10 bar with 3/4" connection external thread											

### TECHNICAL DATA FLEXLINE WITH HEATING ELEMENTS

Type		FLH03	FLH06	FLH09	FLH15	FLH25	FLH30	FLH40	FLH50	FLH80	FLH100	
Steam output	[kg/h]	2,7-3,3	5,5-6,5	8,2-9,8	13,7-16,4	22,7-27,1	27,4-32,7	36,5-43,5	45,5-54,3	73,0-87,0	91,0-108,6	
Electrical connection *		220-240 V / 1 Ph / 50-60 Hz			380-415 V / 3 Ph / 50-60 Hz							
Rated power	[kW]	2,1-2,4	4,1-4,9	6,2-7,3	10,3-12,3	17,1-20,3	20,6-24,5	27,3-32,6	34,1-40,7	2 x 27,3-32,6	2 x 34,1-40,7	
Rated current	[A]	9,4-10,2	18,7-20,4 10,7-11,7	16,0-17,5	15,6-17,1	25,9-28,3	31,3-34,1	41,5-45,4	51,8-56,6	2 x 41,5-45,4	2 x 51,8-56,6	
Fuse **	[A]	1 x 16	1 x 25 3 x 16	3 x 20	3 x 20	2 x 32	3 x 35	3 x 50	3 x 63	2 x 3 x 50	2 x 3 x 63	
Control voltage		220-240 V / N / 2,5 A										
Steam hose connection	[mm]	1 x 40				2 x 40 mit Y		2 x 40		4 x 40		
Unit size ***	Height [mm]	535		695		785		785		785		
	Width [mm]	540		540		640		640		1170		
	Depth [mm]	320		320		420		420		420		
Water installation		Fully demineralised water / cleaned condensate / partially softened water / tap water of varying qualities 1 - 10 bar, for 3/4" external thread										

We reserve the right to make technical changes.

\* Other voltages upon request.

\*\* 1,1-fold power consumption after full blowdown.

Observe actuation characteristics of automatic circuit-breakers. If necessary, select the next highest circuit-breaker level.

\*\*\* External width and depth dimensions. Height including drainage nozzles





## TECHNIQUE FOR HEALING CLAY STEAM BATH

### FUNCTION DESCRIPTION

The system controls the complete treatment of a "Healing Clay Steam Bath" and all necessary components: steam generator, exhaust fan, aroma pump, illumination, solenoid valve for the shower function and sound. The treatment is structured into three time steps. The single time steps can be adjusted individually with rotary knobs at the controller.

#### Treatment time:

The programme is activated by the start push-button on the outside of the cabinet. Then the room light is switched-off and the effect light (e.g. fiber optics or LED RGB illumination for light therapy in a certain colour) is switched-on. During this time the healing clay treatment (scrubbing and drying) is done.

#### Steam time:

Afterwards the steam generator is activated and starts to produce steam on full power. The cabinet is filled with steam and the dry healing clay on the body gets wet.

#### Shower time:

The illumination changes to red. A warm drizzle rain sprays on each guest from nozzles above the seats. This procedure is necessary for the pre-cleaning. The treatment stops after the shower. The effect light is switched-off, the room light and the exhaust fan are switched-on. The controller is ready for a re-start.

There is the possibility to operate the controller only on steam room operation. In this operation mode the controller controls the cabinet like a classic steam room with steam production, exhaust fan and aroma dosing.

### SCOPE OF DELIVERY

A complete package for a "Healing Clay Steam Bath" consists of the following components:

#### Controller:

- Microprocessor controller EDS1 in housing
- Digital thermostat incl. temperature sensor PT100
- Rotary knobs for the adjustment of the single parameters (treatment-, steam-, shower time)
- Power socket for the connection of the aroma pump
- Completely pre-mounted and -wired on PP board grey

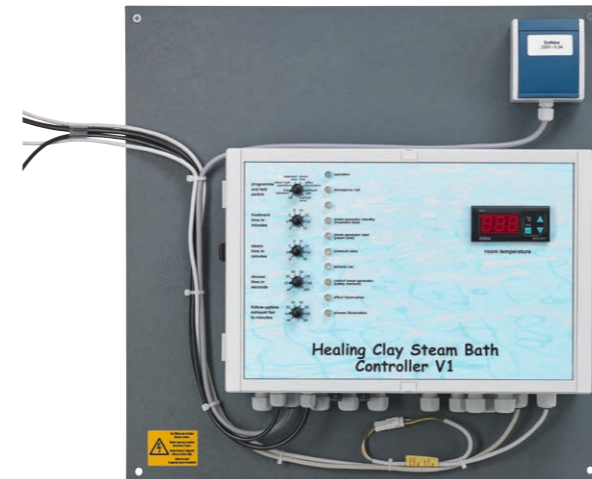

#### Water part:

(Photo: Water part 1/2" for up to 3 seats/nozzles)

- 2 x Supply (warm/ cold) with pre-filter and ball valve female thread
- Thermo mixer JRG with non-return valves
- Outlet with solenoid valve(s) and screwing(s) for the shower function
- Option: unit for thermal disinfection
- Completely tubed, pre-mounted and -wired on PP board grey



The dimensioning of the supplies of the water part and the number of solenoid valves complies with the number of seats / nozzles in the cabinet!

#### Push button plate 1 fold

- With bonnet for in-wall mounting and nameplate for the start of the programme

#### Drizzle Nozzles

- For the shower function according to the number of seats in the cabinet

#### LED illumination

- For steam rooms

#### Fragrance dosing pump

- DUFTDOS-DS

### TECHNICAL DATA

Electrical supply	230 V-AC, 50 Hz
Power supply	500 W
Control contact/-output for steam generator	non-volt contact
Dimensions (W/H/D)	500 x 500 x 200 mm
Weight	app. 7,5 kg

#### Water part 1/2" for up to 3 seats/nozzles

Water supply	2 x 1/2" female thread
Outlet	1 x solenoid valve 1/2"
Dimensions (W/H/D)	200 x 600 x 130 mm
Weight	app. 5 kg

#### Water part 3/4" for up to 6 seats/nozzles

Water supply	2 x 3/4" female thread
Outlet	1 x solenoid valve 3/4"
Dimensions (W/H/D)	250 x 650 x 150 mm
Weight	app. 6 kg

#### Water part 1" for up to 12 seats/nozzles

Water supply	2 x 1" female thread
Outlet	2 x solenoid valve 3/4"
Dimensions (W/H/D)	300 x 700 x 180 mm
Weight	app. 7,5 kg

### TO BE PROVIDED BY THE BUILDER

- Plants room for the installation of the control panels
- Power socket 230V / 50 Hz
- Water connection cold according to no. of nozzles
- Water connection warm according to no. of nozzles
- Needed pressure: 3 bar dynamic
- Water quantity: 6 l/min per nozzles (if Drizzle Nozzles will be used)
- Tubing to the nozzles

### ACCESSORIES / OPTIONS

- Sound module
- 0 - 10 V performance control for stand-by operation of the generator during the treatment time
- Unit for thermal disinfection
- Steam generator
- Exhaust fan







## DOSING SET FOR FRAGRANCE DOSING

Dosing set Part no. 12596 consisting of non-return valve (dosing valve VA  $\frac{3}{8}$ " - 4 x 1) stainless steel and dosing tube (3 m tube PTFE 4 x 1) for a safe connection of the aroma pump with the steam tube. The non-return valve eases necessary maintenance of the pump, as the steam generator does not have to be switched-off in this case.



## PUSH BUTTON FOR STEAM ROOMS

The push button has been developed especially for the use in Wellness areas and steam rooms. It has the protection class IP65. Furthermore the button can be exchanged easily when the unit is already installed and sealed in. The button is available with blue or red ring illumination or without illumination.

### SCOPE OF DELIVERY

- Piezo push button without or with LED-ring illumination 12 - 24 V-DC with recessed grip
- Holder brass chrome plated 60 mm outer diameter
- 7 m cable
- Installation boring 42 mm

### System for tiled surfaces:

- Mounting sleeve D 42 x 110 (40) mm with sealing flange

### System for pre-coated, GFK or Aluminum surface:

- Mounting sleeve D 42 x 110 (40) mm with counter nut



## CONSOLES FOR AROMA PUMPS/-CANISTERS

Consoles to take an aroma pump and an aroma canister/-bottle. The consoles are available for canisters up to 10 l in two different versions:

### Console with wide neck bottle 1,5 l

Part no. 13892 (see photo):  
Dimensions (W/H/D) 195 x 470 x 160 mm

### Console for 10 l canisters (canister excl.)

Part no. 14391:  
Dimensions (W/H/D) 235 x 600 x 240 mm



## EXHAUST FAN RRK

Radial circular in-line fan for the direct installation in the exhaust tubing of steam rooms. Housing made of impact-resistant plastics with round connector.

- Humidity resistant
- Housing made of reinforced plastics
- Performance 230 m<sup>3</sup>/h - free-blowing
- Only vertical installation possible due to condense water!

### TECHNICAL DATA

- mm: 100
- rpm: 2150
- kW: 0,0290
- db(A): 62



© Helios Ventilatoren

## STEAM INLET

Steam inlet cylindrical, to be used as cover for the steam tube in steam rooms. The steam flow is diverted by 90° through holes in order to direct the steam into the cabinet.

### Properties of the steam outlet element:

- Stainless steel V2A brushed, cylindrical
- Diameter 60 mm
- Depth 48 mm (± 2 %)
- 2 openings for steam outlet round d = 30 mm
- Hole on backside 43 mm



## STEAM INLET – MIXING SYSTEM LD

Steam inlet for the mixing and inserting of steam and fresh air into the steam room. For a dense steam appearance and a lower temperature of the inserted steam:

- Mixing tube made of stainless steel V4A with connections for fresh air and steam
- Diameter 110 mm, Installation length 280 mm
- Cover made of stainless steel V4A 130 x 130 mm with fixation screws







## MODULECONCEPT

Due to the fact that there is often very limited space for the technique for steam rooms, we have developed a system, where all technical components for a steam room are pre-installed and pre-wired on a mounting plate. This mounting plate will be installed space saving on a second plate with slide rails in a technique niche. Therefore a quick and easy installation and maintenance of the complete steam room technique is ensured.



## FLEXIBLE PLANNING

- » Pre-installed and pre-wired technical components on mounting plates with slide rails
- » Very low space requirements for the steam room technique due to a compact design
- » Flexible configuration of the necessary components – easy and quick installation
- » Especially synchronised on multifunctional SPA EMOTION steam showers with heat storage ceramic in cooperation with LUX Elements und Sommerhuber Keramik

**We consult you with pleasure about detailed configuration possibilities**





## MODULECONCEPT

**EXEMPLARY SCOPE OF DELIVERY**  
as a complete package for one steam room with  
a room volume of max. 5 m<sup>3</sup> with one bench

### STEAM GENERATOR Details see page 96/97

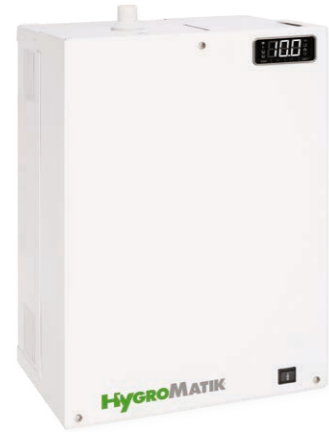

- 1 x Steam generator - Standard Line - SLE05 - Part no. 29459
- 3 m Steam hose DN25 - Part no. 17125
- 1 m Drain hose 1 1/4" - Part no. 17000

### FRAGRANCE PUMP Details see page 84



- 1 x DUFTDOS-0-230V Compact - Part no. 17630



- 1 x Dosing set consisting of:  
Dosing valve VA 3/8" 4 x 1 and 3 m dosing hose  
PTFE 4 x 1 - Part no. 12596

### CONTROL SYSTEM Details see page 135



- Controller in metal control box 380 x 380 x 210 mm (W/H/D) with main switch
- Touch Screen 4,3", 64000 colours, full-graphic
- Box for in-wall mounting of the Touch-Screen
- 2 x PT1000 temperature sensors with 5 m connection cable

**Controls:**

- Steam generator (on/off, temperature controlled)
- Exhaust fan (230 V, temperature controlled)
- Fragrance pump (230 V, pulse-pause time)
- Illumination circuit Spots (230 V, on/off)
- Illumination circuit Linelights (230 V, on/off)
- Bench heating (230 V, on/off, temperature controlled)
- Measuring of the room temperature (PT1000)
- Measuring of the bench temperature (PT1000)
- Connection accumulative fault message of the steam generator

Operation via Touch Screen 4,3", 64000 colours, full-graphic with box for in-wall mounting

### ILLUMINATION Details see page 90/92/94



- 2 x LED Spots warm white IP67 - Part no. 21640 (quantity according to detailed cabinet size)
- 2 x Mounting sleeve for LED (quantity according to detailed cabinet size, characteristic according to ceiling construction)
- 1 x Extension cable (quantity and lengths according to detailed cabinet size)



- 1 x Dimmable transformer for LED Spots warm white - Part no. 27404

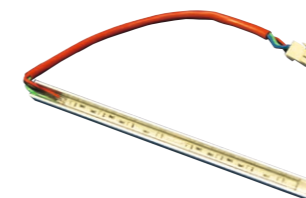

Linelights according to lengths and shape of the bench on demand

### MOUNTING BOARDS / GUIDE-RAIL Details see page 90/92/94



Factory-made pre-installation of above components on mounting boards with guide-rails consisting of:

- 2 x Mounting board (1 x base- / 1 x guide-rail-board) W 700 mm x H 1830 mm x D 550 mm
- 3 x Guide-rail
- Factory-made pre-installation and -wiring





## TECHNIQUE FOR SAUNAS

Only an aromatic sauna splash creates a perfect sauna experience! Our automatic water and aroma splash system for sauna heaters is an important product of our Wellness portfolio.

Our LED illumination systems which are especially designed and produced for saunas create special light effects. A glass rod decouples the LED illuminant from the hot sauna temperatures. This system allows the use of up-to date LED techniques in saunas.

108 Dosing-system for an automatic sauna-splash

110 LED illumination

# HEAT



## FEEL-GOOD CLIMATE

- » Higher efficiency operation of your sauna with the WDT splash system and the WDT-LED illumination
- » Regular splash with a pre-defined intensity
- » Safe prevention of an overdosing of fragrance
- » The water quantity of the splash can be adapted to the capacity of the heater: this helps to prevent unpleasant water puddles below the heater and unnecessary wear on the sauna heater

**We consult you with pleasure about detailed configuration possibilities**





## SAUNA-PLUS 8 BASIC

### FUNCTION DESCRIPTION

Dosing-system for an automatic sauna-splash with fragrance and water. The Sauna-Plus 8 Basic systems has two operation modes: cyclic- and push-button operation. An external control via non-volt- or 230 V signal is possible. Operation and visualisation via 5-line LC display and three buttons. Fault indications are displayed in plain text. Setting possibilities: switch-on delay, water quantity, fragrance intensity, cycle time for cyclic operation and locking time for push-button operation.

The system is designed for max. one aroma pump.

### SCOPE OF DELIVERY

- Controller NT35R with 5-line LC display installed in housing
- Peristaltic pump Sa-Vi for fragrance concentrate
- Mounting board with console for max. 5 l fragrance canister
- Supply with ball valve 1/2" female thread and pre-filter
- Tube aerator according to DIN EN 1717
- Solenoid valve VA 1/4"
- Pressure monitoring as safety device
- Dosing tube with dosing valve 3/8" stainless steel
- Outlet 3/8" female thread
- Splash sprinkler 3/8" female thread

### TECHNICAL DATA

Electrical supply	100 - 240 V-AC, 50 - 60 Hz
Power supply	max. 50 W
Water supply	1/2" female thread
Water outlet	3/8" female thread
Water quantity	app. 2,5 l/min
Pre-pressure min.	1,5 bar
Pre-pressure max.	5 bar
Dimensions (W/H/D)	400 x 710 x 240 mm
Weight	app. 15 kg
Temperature range	+10 to +35 °C
Protection class	IP44



### TO BE PROVIDED BY THE BUILDER

- Plants room for the installation of the control panel
- Power socket 230 V / 50 Hz (interlocked with sauna controller)
- Water connection cold 1/2"
- Needed pressure: 1,5 bar dynamic
- Water quantity: 2,5 l/min
- 3/8" tubing to the sprinkler
- Drain in the plants room

**! The system has to be installed on a higher level than the sprinkler. If this is not possible or if the tubing goes upwards, a non-return valve DIN EN 1717 has to be installed in the supply - in this case we recommend to use the sauna connection set - see options !**

### ACCESSORIES / OPTIONS

- Grommet Part-no. 15214  
(Photo shows sprinkler and grommet)



- Sprinklers in special lengths and shapes
- Push button plate
- Sauna splash connection set consisting of:
  - 10 meter PTFE dosing tube
  - Tube adapter Sauna Plus 3/8" x 6x1
  - Tube adapter splash nozzle 3/8" x 6x1
  - 3/8" angle female/male thread

## SAUNA-PLUS 8

### FUNCTION DESCRIPTION

Dosing-system for an automatic sauna-splash with fragrance and water. The system is available with one up to four aroma pumps. The Sauna-Plus 8 systems has three operation modes: cyclic-, clock timer- and push-button operation. The operation and splash times can be saved individually in the integrated week-program. Operation and visualisation via 3.2" full colour Touch-Display. In addition to the standard settings like water-, aroma quantity and splash time the system offers many additional adjustable parameters. Different aromas can be assigned to single splashes in individual quantities for example. Furthermore a splash pre-indication can be connected or the splash can be combined with light and sound effects. Another feature is to send a signal from the system to the heater to activate the pre-heating before the splash. The controller includes several password protected authorization levels. Each level allows different settings.

### SCOPE OF DELIVERY

- Controller with 3,2" Touch display installed in housing
- Peristaltic pump(s) Sa-Vi for fragrance concentrate
- Mounting board with console for max. 5l fragrance canister
- Supply with ball valve 1/2" female thread and pre-filter
- Tube aerator according to DIN EN 1717
- Solenoid valve VA 1/4"
- Pressure monitoring as safety device
- Dosing tube with dosing valve 3/8" stainless steel
- Outlet 3/8" female thread
- Splash sprinkler 3/8" female thread
- Design cover

### TECHNICAL DATA

Electrical supply	230 V-AC, 50 Hz
Power supply	max. 50 W
Water supply	1/2" female thread
Water outlet	3/8" female thread
Water quantity	app. 2,5 l/min
Pre-pressure min.	1,5 bar
Pre-pressure max.	5 bar
Dimensions (W/H/D)	470 x 710 x 240 mm
Weight	app. 15 kg
Temperature range	+10 to +35 °C
Protection class	IP44



### TO BE PROVIDED BY THE BUILDER

- Plants room for the installation of the control panel
- Power socket 230 V / 50 Hz (interlocked with sauna controller)
- Water connection cold 1/2"
- Needed pressure: 1,5 bar dynamic
- Water quantity: 2,5 l/min
- 3/8" tubing to the sprinkler
- Drain in the plants room

**! The system has to be installed on a higher level than the sprinkler. If this is not possible or if the tubing goes upwards, a non-return valve DIN EN 1717 has to be installed in the supply - in this case we recommend to use the sauna connection set - see options !**

### ACCESSORIES / OPTIONS

- Grommet Part no. 15214  
(Photo shows sprinkler and grommet)



- Grommet Part no. 15214 (Photo shows sprinkler and grommet)
- Sprinklers in special lengths and shapes
- Effect illumination
- MP3 player and speaker
- Push button plate
- Sauna splash connection set consisting of:
  - 10 meter PTFE dosing tube
  - Tube adapter Sauna Plus 3/8" x 6x1
  - Tube adapter splash nozzle 3/8" x 6x1
  - 3/8" angle female/male thread





## LED SPOTS AND MOUNTING SLEEVES

### FUNCTION DESCRIPTION

The spots have especially been developed for the use in saunas. The spots have the protection class IP65 and they are operated with low voltage. Furthermore, the spotlights can be exchanged easily when they are already installed and sealed in. The spots are available in LED RGB, RGBW or Warm White. As the spots are prepared with plug ready to use, an easy and trouble free installation is ensured.

### SCOPE OF DELIVERY

- LED illuminant RGB, RGBW or warm white
- Holder chrome plated brass, stainless steel or aluminium coated (colour on demand)
- Lense and glass rod (optical fiber)
- Installation boring 50 mm
- Cover 60 mm outer diameter
- Mounting sleeve Alu D 50 x 40 mm with crawls
- Incl. connection cable 20 cm JST
- PTFE temperature barrier
- Cooling element

### TECHNICAL DATA

	RGB	RGBW	Warm White
Control signal		350 mA constant current	
Power supply	3 x 1 W	4 x 1 W	1 W
Light colour	Red/Green/Blue	Red/Green/Blue/Warm White	Warm White 2700 K
Installation boring		50 mm	
Weight		app. 0,45 kg	
Installation depth		150 mm	
Diameter of the cover		60 mm	
Protection class		IP65	

### ACCESSORIES / OPTIONS

- The spots are connected in series. For the connection of the single spots there are extension cables available: 1,5 - 2,5 - 5,0 - 7,0 - 15,0 m
- Available for control signal 700 mA constant current



### AUFBAU:

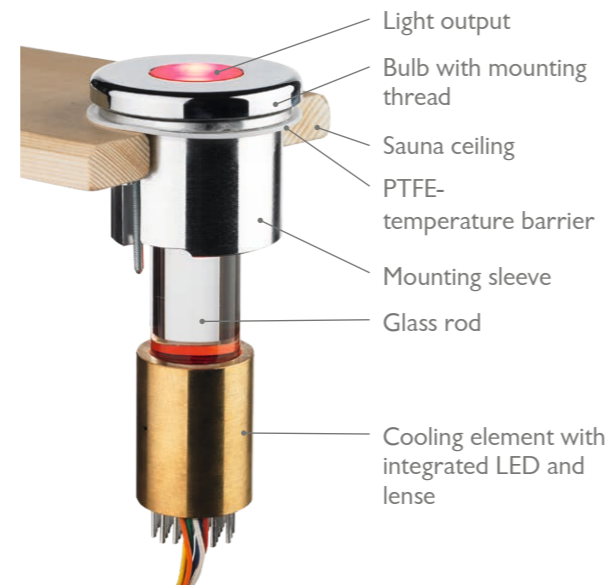

## CONTROLLER FOR LED SPOTS RGB / RGBW

### FUNCTION DESCRIPTION

Controller for LED spots RGB or RGBW with an operation current of 350 mA. You can connect up to 10 pieces of RGB or RGBW spots to one controller. The controller can realise six (respectively seven at RGBW) static light colours and nine (respectively eight at RGBW) light programmes. The different light programmes are set by a code switch at the housing. Optionally the light programmes can be controlled externally by a four-digit digital code. The connected spotlights can be dimmed by a second poti at the control housing.

If more than 10 spots are required the controllers can be extended by Slave modules.

### SCOPE OF DELIVERY

- LED RGB or RGBW control board installed in housing
- Code switch for the setting of the desired light programme
- Poti for the manual dimming of the connected spotlights
- 7 m cable from the controller to the 1<sup>st</sup> spot
- 1,5 m power supply cable with Euro plug

### TECHNICAL DATA

	RGB	RGBW
Electrical supply	230 V-AC, 50 - 60 Hz	
Power supply	42 VA	
Temperature range	0 to +50 °C	
Weight	1,5 kg	2,7 kg
Dimensions (W/H/D)	130 x 180 x 90 mm	200 x 250 x 120 mm

### ACCESSORIES / OPTIONS

- Available with operation- / constant current 700 mA
- Slave controller for external control / colour choice by a 4 digit HEX Code



Example photo:  
RGBW controller without code switch and without dim poti





## LINELIGHT / LIGHT RAILS

### FUNCTION DESCRIPTION

LED linelights with an operation voltage of 12 V-DC, available in LED RGB or warm white. Ideal for indirect illumination or illumination under the benches of saunas in casted version with 12 x 12 mm Aluminium profile. The Linelights are produced to order in the desired lengths.

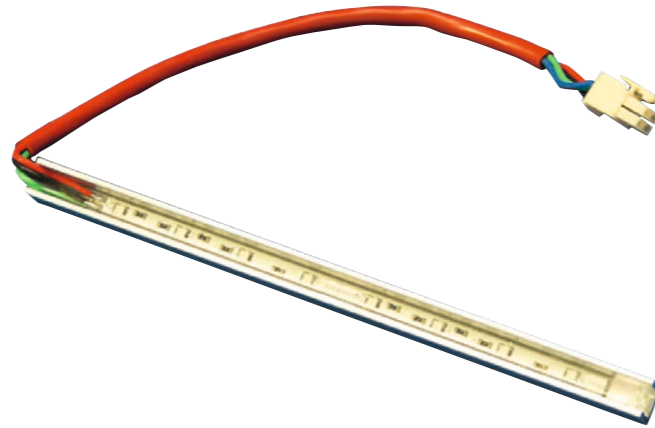

### SCOPE OF DELIVERY

#### LED- Linelight Aluprofile IP65

- Equipped with SMD-LEDs, casted with transparent 2-component resin
- Incl. connection cable and plug
- Available lengths from 119 mm up to 3000 mm

### TECHNICAL DATA

	RGB	Warm White
Control signal	12 V-DC RGB - / com+	12 V-DC
Light colour	Red/Green/Blue	Warm White 2700 K
Dimensions (W/H/L)	12 x 12 mm x length	
Temperature range	-20 to +60 °C max.	
Protection class	IP65	

### ACCESSORIES / OPTIONS

- Extension cables incl. connector
- Y-cable 4-poles incl. connector



## CONTROLLER FOR LED LINELIGHTS RGB / RGBW

### FUNCTION DESCRIPTION

Controller for LED Linelights RGB or RGBW with an operation voltage of 12V-DC. You can connect up to 105 W of RGB- or 180 W of RGBW linelights to one controller. The controller can realise six (respectively seven at RGBW) static light colours and nine (respectively eight at RGBW) light programmes. The different light programmes are set by a code switch at the housing. Optionally the light programmes can be controlled externally by a four-digit digital code. The connected lights can be dimmed by a second poti at the control housing.

If more than 105 W RGB respectively 180 W RGBW are required the controllers can be extended by Slave modules.

### SCOPE OF DELIVERY

- LED RGB or RGBW control board installed in housing
- Code switch for the setting of the desired light programme
- Poti for the manual dimming of the connected spotlights
- 1,5 m power supply cable with Euro plug

### TECHNICAL DATA

	RGB	RGBW
Electrical supply	230 V-AC, 50 - 60 Hz	
Power supply	150 VA	180 VA
Temperature range	0 to +50 °C	
Weight	2,8 kg	2,7 kg
Dimensions (W/H/D)	260 x 220 x 110 mm	200 x 250 x 120 mm

### ACCESSORIES / OPTIONS

- Available with operation voltage 24 V-DC
- Transformer for warm white
- Slave controller for external control / colour choice by a 4 digit HEX Code



Example photo:  
RGBW controller without code switch  
and without dim poti



## NEBULISATION OF BRINE SOLUTION

The positive influence of brine and salt for human beings is undisputed in medical science. Its use has a very long tradition in the history. Scientific studies prove that the inhalation of salt leads to a better humidification and blood circulation of the mucosa of the airways, which supports the natural cleaning function.

The beneficial effect of brine and salt plays also an important role in the Wellness market. Meanwhile many hotels and SPAs offer a huge variety of salt treatments to their guests. Brine steam rooms, salt saunas, salt grottos and relaxation rooms with a special salt atmosphere and many others.

WDT offers suitable and professional systems for all applications mentioned above. The used brine solution is atomised either by an ultrasonic mist maker, or nebulised by very fine spray nozzles. As the bather is breathing the salt mist into the airways, the brine system and solution have to be hygienically impeccable. Therefore, our systems offer sterilised brine solution in an air-sealed bag and an integrated disinfection concept for a safe and clean brine treatment.

115 For steam rooms

116 For dry rooms

## SOLDOS-V3

### FUNCTION DESCRIPTION

Nebulisation system for brine solution to create a salty sea climate in steam rooms. The Soldos sprays fine nebulised, sterile brine solution into steam rooms. After a short time, you get a salty sea climate in the room. The brine solution is primed out of an air-sealed bag (Politainer), which prevents the contamination of the brine solution with germs from the ambient air. Then the brine is pressed through a very fine nozzle by a high-pressure solenoid diaphragm pump and nebulised. Furthermore a disinfection system is integrated. Operation via 3,2" full colour Touch display with a multitude of possibilities:

- Operation modes: cyclic-, clock timer- and external control
- Week-program for the definition of the individual operation times per day
- Combination of the salt spray with light and sound effects
- Pressure monitoring for brine filling level and blockage nozzle
- Day counter for the indication of a possible necessary disinfection and visual description of this procedure
- Definition of several authorization levels. Each level allows different settings

### SCOPE OF DELIVERY

- Controller with 3,2" Touch installed in housing
- Motor diaphragm pump, low noise
- Mounting board with console for brine bag
- Nozzle stainless steel V4A with cover screen PE
- Mounting sleeve and 5 m dosing tube PTFE
- Disinfection set with disinfection tablet, mixing bottle and recipient
- 5 kg sterile brine solution in Politainer (resp. 1 kg for private use)
- Design cover

### TECHNICAL DATA

Area of application	Steam rooms with a floor space of app. 25 m <sup>2</sup> (depending on air exchange rate)
Electrical supply	230 V-AC, 50 Hz
Power supply	350 W
Dimensions (W/H/D)	470 x 710 x 240 mm
Empty Weight / Operational Weight	app. 15 kg / 20 kg
Temperature range	+10 to +35 °C
Protection class	IP44
Brine consumption at app. 10 h operation/day (system settings 10 min. pause/10 sec. dosing)	app. 1 kg / day



Photo: Nozzle and grommet

### TO BE PROVIDED BY THE BUILDER

- Plants room for the installation of system
- Power socket 230 V, 50 Hz

### POINTS TO BE CONSIDERED BEFORE THE INSTALLATION:

- Before the installation of a SOLDOS all materials have to be checked on their corrosion resistance against the saline mixture of water and air both in the adequate steam cabinet and additionally in the ventilation pipework
- The SOLDOS is not licensed for medical purpose.
- Use only pure, sterilised WDT brine solution with a salt concentration of app. 5 %. WDT brine solution is delivered in a sterile condition in a closed bag. Outstanding brine solution is affected by bacterial impact and so should not be used
- In order to prevent drainage of the Politainer, the nozzle has to be installed on a higher level than the SOLDOS. If this is not possible a spring loaded non-return valve has to be installed in the dosing tube.
- The SOLDOS-V3 is not useful for dry rooms (Tepidarium etc.). For this purpose we recommend to use the SOLDOS-SL or SOLFOG system

### ACCESSORIES / OPTIONS

- Push button plate with in-wall box for flush mounting
- 2<sup>nd</sup> pump and nozzle for cabinets with a bigger floor-space as 25 m<sup>2</sup>
- Illumination
- MP3 player and speaker
- Nozzle cover screen in stainless steel





## SOLDOS SL-V3

### FUNCTION DESCRIPTION

Nebulisation system for brine solution to create a salty sea climate in dry rooms. The SOLDOS-SL sprays a very fine nebulised, sterile brine solution into dry rooms. After a short time you get a salty sea climate in the room. The brine solution is primed out of an air-sealed bag (Politainer), which prevents the contamination of the brine solution with germs from the ambient air. Then the brine is pressed by a peristaltic pump through a two-component jet nozzle where it is mixed with compressed air and nebulised. Furthermore a disinfection system is integrated. Operation via 3,2" full colour Touch display with a multitude of possibilities:

- Operation modes: cyclic-, clock timer- and external control
- Week-program for the definition of the individual operation times per day
- Combination of the salt spray with light and sound effects
- Empty switch for a switch-off of the system when brine will get empty
- Day counter for the indication of a possible necessary disinfection and visual description of this procedure
- Definition of several authorisation levels. Each level allows different settings

### SCOPE OF DELIVERY

- Controller with 3,2" Touch installed in housing
- Peristaltic pump SA with rpm control for the adjustment of the dosing quantity / salt concentration
- Water separator
- Mounting board with console for brine bag
- Solenoid piston compressor (standing on the floor)
- Two-component jet nozzle stainless steel V4A with cover screen, mounting sleeve, 5 m air tube PE and 5 m brine tube PTFE
- Disinfection set with disinfection tab, mixing bottle and recipient
- 5 kg sterile brine solution in brine bag (resp. 1 kg for private use)
- Design cover

### TO BE PROVIDED BY THE BUILDER

- Plants room for the installation of system
- Power socket 230 V, 50 Hz



Nozzle with mounting sleeve



Compressor



### TECHNICAL DATA

Area of application	Tepidariums, Saunas, Salt Rooms with a floor space of app. 35 m <sup>2</sup> (depending on air exchange rate)
Electrical supply	230 V-AC, 50 Hz
Power supply	455 W
Dimensions (W/H/D)	470 x 710 x 240 mm
Dimensions compressor (W/H/D)	240 x 250 x 160 mm
Empty Weight / Operational Weight	app. 20 kg / 25 kg
Noise emission in the plants room	80 dB(A)
Noise emission in one meter distance to the nozzle	70 dB(A)
Temperature range	+10 to +35 °C
Protection class	IP44
Brine consumption at app. 10 h operation/day (system settings 10 min. pause/10 sec. dosing)	app. 1 kg / day

### POINTS TO BE CONSIDERED BEFORE THE INSTALLATION:

- Before the installation of a SOLDOS all materials have to be checked on their corrosion resistance against the saline mixture of water and air both in the adequate room and additionally in the ventilation pipework
- The SOLDOS is not licensed for medical purpose
- Use only pure, disinfected WDT brine solution with a salt concentration of app. 5 %. WDT brine solution is delivered in a sterile condition in a closed bag. Outstanding brine solution is affected by bacterial impact and so should not be used

### ACCESSORIES / OPTIONS

- Push button plate with in-wall box for flush mounting
- 2<sup>nd</sup> pump and nozzle for cabinets with a bigger surface square as 35 m<sup>2</sup>
- Illumination
- MP3 player and speakers
- Nozzle cover screen in stainless steel

## SOLFOG-V3

### FUNCTION DESCRIPTION

The SOLFOG generates a very fine, dry fog made of ultra-pure brine solution by an ultrasonic mist maker. This dense fog is delivered to the room through an airstream that is produced in the unit. Thereby a salty sea climate is created in the according room. The brine solution is primed out of an air-sealed bag (Politainer), which prevents the contamination of the brine solution with germs from the ambient air. Additionally the according room can be aromatised by the system. For this reason aroma oil concentrate is evaporated in the system and the aromatised air is blown into the room together with the salty fog. Operation and visualisation via 5-line LC display and three buttons. Fault indications are displayed in plain text. The SOLFOG has three operation modes: cyclic operation, push-button operation or external control.

### SCOPE OF DELIVERY

- Controller NT35 with 5-line LC display installed in housing
- Peristaltic pump SA for brine re-feeding
- Ventilator
- Ultra sonic fog maker
- Fog chamber
- Mounting board with console for brine bag max 5 l
- Disinfection set with disinfection tablet, mixing bottle and recipient
- 5 kg sterile brine solution in politainer (resp. 1 kg for private use)
- Inlet nozzle PVC D40 with cover screen

### POINTS TO BE CONSIDERED BEFORE THE INSTALLATION:

- Before the installation of a SOLFOG all materials have to be checked on their corrosion resistance against the saline climate, even the ventilation pipework
- The SOLFOG is not licensed for medical purpose
- Use only pure, disinfected WDT brine solution with a salt concentration of app. 5 %. WDT brine solution is delivered in a sterile condition in a closed bag. Outstanding brine solution is affected by bacterial impact and so should not be used
- The optional fragrance dosing only works in rooms with a max. room temperature of app. 60 °C

### WATCH OUR SOLFOG VIDEO.

Scan the QR code or search for "WDT Solfog" on youtube.



### TECHNICAL DATA

Area of application	Relax Rooms, Saunas, Salt Rooms, Infrared Cabinets with a floor space of app. 20 m <sup>2</sup> (depending on air exchange rate)
Electrical supply	230 V-AC, 50 Hz
Power supply	50 W
Dimensions (W/H/D)	400 x 710 x 250 mm
Empty Weight / Operational Weight	app. 11 kg / 16 kg
Temperature range	+10 to +35 °C
Protection class	IP44
Brine consumption at app. 10 h operation/day (system settings 10 min. pause/10 sec. dosing)	app. 0,2 kg / day
Connection fog tube	d 40 mm
Input for external control	non-volt or 230 V contact
Output for fault indication	non-volt contact

### TO BE PROVIDED BY THE BUILDER

- Plants room for the installation of system
- Power socket 230 V, 50 Hz
- Tubing in PVC(C) to the room

### ACCESSORIES / OPTIONS

- Push button plate with in-wall box for flush mounting
- Cover screen brass chromed
- Illumination for fog outlet
- Aroma





## FOAM FOR HAMMAM MESSAGES

Oriental pleasure. The Hammam is an important part of the Islamic bathing and body culture. It is also well-known under the name "Turkish bath" or "Oriental bath". Washing is a fundamental ritual in the Hammam. For this purpose, a cotton bag is soaped by the Hammam master, then filled with air by swinging it round. The foam is stripped-off the textile and rubbed onto the body for the massage.

This ritual inspired us for the development of our product FOAMDOS. As in the traditional method, a pleasant smelling foam is produced by the elements water, air and soap, but automatically on demand. The foam can be brought onto the body by a hand shower. The massage is done either by the guests themselves or by a masseur.

The system has originally been designed for the installation under a massage table. The design is therefore very compact. The unit is easy to install and maintain.

# FOAM MASSAGE

## FOAMDOS V6

### FUNCTION DESCRIPTION

The FOAMDOS produces foam for Hammam massages by the three components water, air and foam agent. The foam outlet is done via a hand shower or through a faucet installed in the wall. Furthermore a shower function with warm water is integrated. The dosing quantity of the foam agent, the water flow rate and therefore the consistency of the foam is adjustable individually at the controller. Operation and visualisation via 5-line LC display and three buttons. Both functions are started by a push-button.

### SCOPE OF DELIVERY

- Controller with 5-line LC display installed in housing
- Diaphragm air pump 7006 AC
- Supply with pre-filter and ball valve MS ½" female thread
- Non-return according to DIN EN1717
- Pressure gauge
- Flow regulator
- 2 x Solenoid valve ¾"
- Foam generator
- Peristaltic dosing pump SA
- Suction lance d 12 - 420 mm
- 2 x Dosing valve for foam agent and air
- 3 m hose PVC 12 x 1,5 transparent for the outlet of the foam
- Push button plate 2-fold
- Completely tubed and pre-wired on PP board grey

### TECHNICAL DATA

Electrical supply	230 V-AC, 50 Hz
Power supply	150 W
Water supply	½" female thread
Dimensions (W/H/D)	500 x 500 x 250 mm
Weight	app. 10 kg



### TO BE PROVIDED BY THE BUILDER

- Plants room for the installation of the control panel
- Power socket 230 V
- Thermo mixer / Water supply mixed water ½"
- Needed pressure: 2 bar dynamic
- Water quantity: app. 10 l/min
- Waste water connection for the non-return device
- Drain in the plants room
- Foam outlet: hand shower or wall outlet with bowl

### ACCESSORIES / OPTIONS

- Thermo mixer
- Hand Shower for the foam outlet
- Emptying







## FOOT BATH SPUTTERING SYSTEM

Keeping healthy according to the famous German pastor, Kneipp. Taking alternating hot and cold water foot baths is an approved therapy method. It has been proven that stress levels can be reduced by alternating cold and warm water. Foot baths also improve the cardiovascular system. The "Guidelines for the building of Saunas" by the association "Deutscher Sauna-Bund e.V." recommends the use of foot baths in between of sauna sessions.

122 Technique

124 Basins

# HOT & COLD



## STIMULATING

- » Optimal relaxation by automated foot bath treatment and the stimulation of the foot reflex zones
- » Hygienically impeccable due to integrated disinfection system
- » High grade of flexibility and individuality in the design as we are able to offer foot basins made of ceramics or Corian® beside the technical systems

**We consult you with pleasure about detailed configuration possibilities**





## FOOT BATH SPUTTERING SYSTEM FOR 2 BASINS

### FUNCTION DESCRIPTION

The programme is activated by a push-button. The guest has the choice between a cold or warm water treatment. After pressing the button the filling of the basin starts. It stops when an adjustable water level is reached. Then the bubbling starts automatically for a programmable time. After the lapse of this time the bubbling stops and a dwell time follows. Afterwards the basin is emptied automatically. During the dwell time the bubbling can be restarted before the emptying. During the filling procedure a chlorine solution is dosed to disinfect the whole system (drain-, air piping and basin) and the feet of the user. Both basins can be operated independent from each other.

### SCOPE OF DELIVERY

#### Controller consisting of:

- 2 x Microprocessor controller EDS1 in housing
- Potis for the adjustment of the single parameters (sputtering time, dwell time...)
- 2 x Pressure switch and 2 x pressure measuring device for the regulation of the water level
- Completely pre-wired on PP board grey

#### Water part consisting of:

- 2 x Supply (warm/ cold) with pre-filter and ball valve 1" female thread
- Thermo mixer JRG 1" with non-return valves
- 4 x outlet with solenoid valve 3/4" and screwing for the filling
- Completely tubed and pre-wired on PP board grey

#### 2 x Push button plate 2 fold

- With bonnet for in-wall mounting and name plates for the start of the programme

#### 2 x Peristaltic pump

- With console and bottle 1,5 l for the disinfection incl. dosing tube and dosing valve

#### 2 x Side channel vacuum blower

- 0,20 kW 230 V, 50 HZ, IP55 for sputtering effect

#### 2 x Motor-ball valve

- 2-ways PVC DN32 PTFE/EPM 230 V-AC D40 S6 max. 3,5 bar for the automatical drainage of the basin



### TECHNICAL DATA

#### Controller

Electrical supply	230 V-AC, 50 Hz
Power supply	max. 600 W
Dimensions (W/H/D)	500 x 400 x 150 mm
Weight	4 kg

#### Water part

Water supply	2 x 1" female thread
Outlet to the 2 basins	4 x solenoid valve 3/4"
Dimensions (W/H/D)	500 x 500 x 150 mm
Weight	10 kg

#### Water consumption according to basin dimensions!

### TO BE PROVIDED BY THE BUILDER

- Plants room for the installation of the control panels
- Power socket 230 V / 50 Hz
- Water connection cold 1"
- Water connection warm 1"
- Needed pressure: 3 bar dynamic
- Water quantity: according to basin dimensions
- Tubing to water outlet 2 x DN20
- Drainage tube 2 x DN40
- Air tube 2 x DN25
- 2 x Basin with false floor
- Tubing of the overflow

### ACCESSORIES / OPTIONS

- LED RGB illumination for the basins
- Basins with false floor made of ceramics or Corian® on demand

## FOOT BATH SPUTTERING SYSTEM FOR 1 BASIN

### FUNCTION DESCRIPTION

The programme is activated by a push-button. The guest has the choice between a cold or warm water treatment. After pressing the button the filling of the basin starts. It stops when an adjustable water level is reached. Then the bubbling starts automatically for a programmable time. After the lapse of this time the bubbling stops and a dwell time follows. Afterwards the basin is emptied automatically. During the dwell time the bubbling can be restarted before the emptying. During the filling procedure a chlorine solution is dosed to disinfect the whole system (drain-, air piping and basin) and the feet of the user. Both basins can be operated independent from each other.

### SCOPE OF DELIVERY

#### Controller consisting of:

- 1 x Microprocessor controller EDS1 in housing
- Potis for the adjustment of the single parameters (sputtering time, dwell time...)
- 1 x Pressure switch and 2 x pressure measuring device for the regulation of the water level
- Completely pre-wired on PP board grey

#### Water part consisting of:

- 2 x Supply (warm/ cold) with pre-filter and ball valve 3/4" female thread
- Thermo mixer JRG 3/4" with non-return valves
- 2 x outlet with solenoid valve 3/4" and screwing for the filling
- Completely tubed and pre-wired on PP board grey

#### Push button plate 2 fold

- With bonnet for in-wall mounting and name plates for the start of the programme

#### Peristaltic pump

- With console and bottle 1,5 l for the disinfection incl. dosing tube and dosing valve

#### Side channel vacuum blower

- 0,20 kW 230 V, 50 HZ, IP55 for sputtering effect

#### Motor-ball valve

- 2-ways PVC DN32 PTFE/EPM 230 V-AC D40 S6 max. 3,5 bar for the automatical drainage of the basin



### TECHNICAL DATA

#### Controller

Electrical supply	230 V-AC, 50 Hz
Power supply	max. 300 W
Dimensions (W/H/D)	350 x 350 x 150 mm
Weight	2 kg

#### Water part

Water supply	2 x 3/4" female thread
Outlet to the basin	2 x solenoid valve 3/4"
Dimensions (W/H/D)	410 x 440 x 150 mm
Weight	8 kg

#### Water consumption according to basin dimensions!

### TO BE PROVIDED BY THE BUILDER

- Plants room for the installation of the control panels
- Power socket 230 V / 50 Hz
- Water connection cold 3/4"
- Water connection warm 3/4"
- Needed pressure: 3 bar dynamic
- Water quantity: according to basin dimensions
- Tubing to water outlet DN20
- Drainage tube DN40
- Air tube DN25
- Basin with false floor
- Tubing of the overflow

### ACCESSORIES / OPTIONS

- LED RGB illumination for the basins
- Basins with false floor made of ceramics or Corian® on demand





## FOOT BASINS MADE OF CERAMICS



The foot basins made of ceramics have been developed together with the company Sommerhuber especially for the foot bath sputtering system. They are available square- or round shaped.

The basins are casted in one piece and glazed from the interior and from the outside. A false floor made of Corian® is installed by WDT in the basin to realise the sputtering function. The glazing of the ceramics and the colour of the floor are adjusted to each other.

An additional part made of ceramics is available for the installation of the faucets (provided by the client or by WDT) and the buttons for the start of the programmes. The basins with additional part are available for single as well as for double foot bath sputtering systems.

## GLAZES SPA CERMAICS



311 sahara



313 umbra



429 basalt light

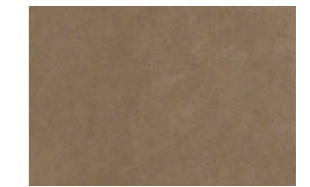

430 basalt medium



431 basalt dark



446 pebble

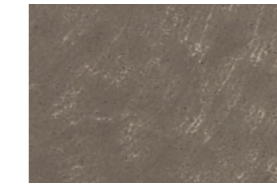

448 graphite



449 lava

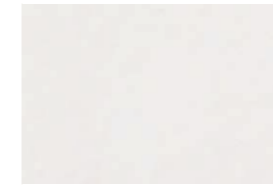

453 enamel white matt



454 edelweiss



457 savanne light



470 fjord light

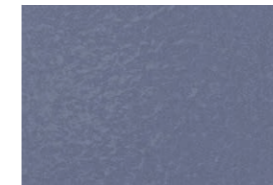

471 fjord medium

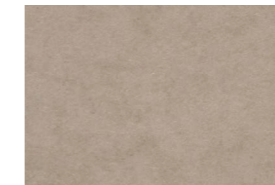

478 taupe medium

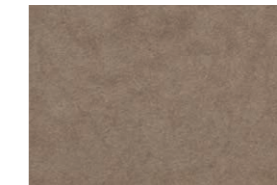

479 taupe dark

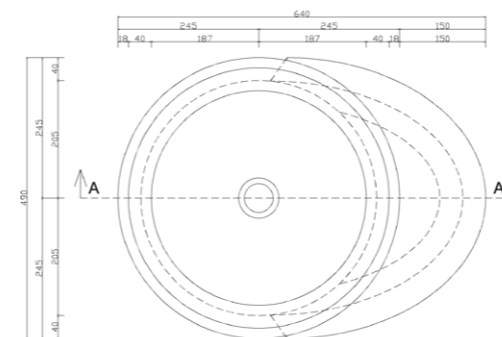

Cut view  
1-1

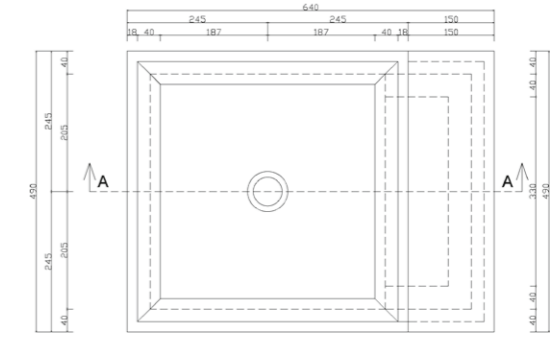
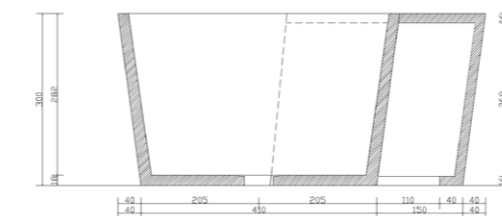

Cut view  
1-1

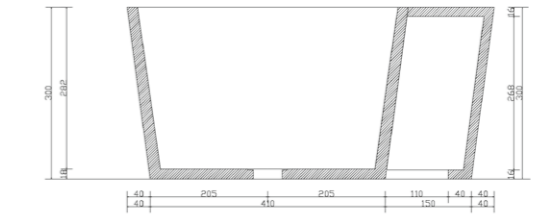





## FOOT BASINS MADE OF CORIAN®

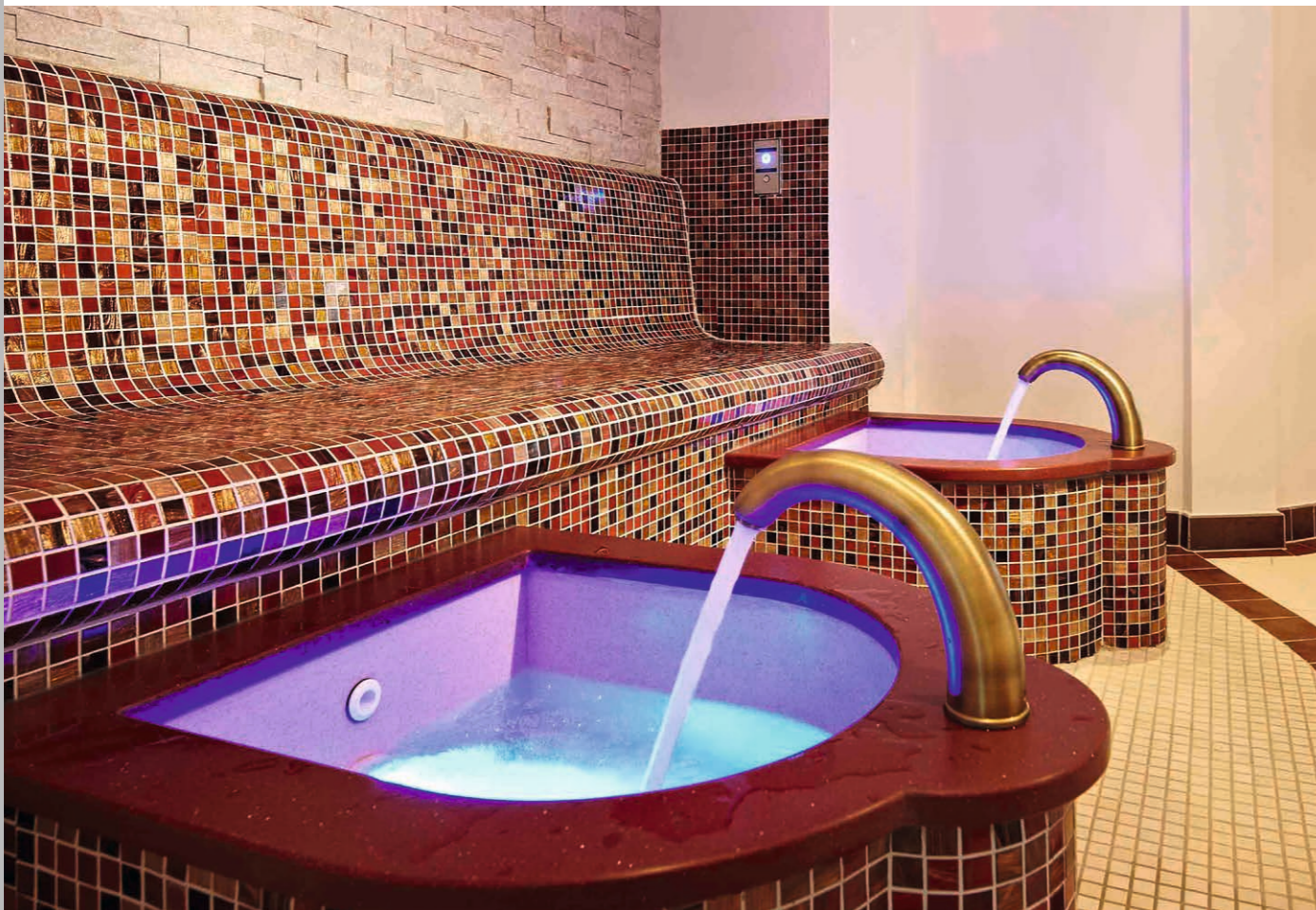

The foot basins made of Corian® have been developed especially for the foot bath sputtering system. They are available in many different shapes (e.g. rectangular, round, half-round) and colours. Nonporous and stain-resistant, Corian® is easy to clean, making it an ideal surface for Wellness & SPA.

For the sputtering function, WDT installs a revisable false floor made of Corian®.

The faucets (provided by the client or by WDT) can be integrated by a boring into the basin or by an additional frame onto the basins. The buttons for the start of the programmes are in general installed next to the basin. They can either stand-alone or be installed in a way, that the outside is tiled. It is also possible to tile the inside.







## ROOM AROMATISATION

A pleasant aroma increases the recreational value of a wellness treatment. For the aromatisation of dry rooms like relaxation areas, tepidariums, caldariums and infra-red cabinets, you can only use air as a carrier medium for the aroma. Our systems for room aromatisation have been especially developed for this application.

Our equipment is designed to use the principle of evaporation. Air is blown over the surface of a fragrance oil concentrate and evaporates the volatile parts of the oil.

This aromatised air is then blown into the room by a small compressor or a blower. Because of this process, no aroma aerosol has to be sprayed into the room. Therefore no residue of the fragrance will be present around the aroma outlet or in the room. The low-volatile parts of the fragrance settle at the bottom of the aroma bottle. This bottle can be changed or re-filled very easily and cleanly. The systems work up to room temperatures of app. 50 °C and are available for one or several aromas.

# AROMATIC

## AEROM POWER



### FUNCTION DESCRIPTION

System for the aromatisation of rooms up to a volume of app. 100 m<sup>3</sup>, depending on the air exchange rate. For the installation in the room that has to be aromatised. A small blower blows air over the surface of a fragrance concentrate filled into a little bottle. The fragrance concentrate evaporates and is blown into the room. The intensity of the aroma can be adjusted by a rotary knob at the housing.

### SCOPE OF DELIVERY

- Controller DS
- Ventilator
- Bottle adapter
- PET-bottle 250 ml
- Filter star for the increase of the surface
- Housing with all components installed

### TECHNICAL DATA

Electrical supply	230 V-AC, 50 Hz
Power supply	app. 10 W
Evaporation performance max.	app. 5 ml of aroma in 24 h (depending on the aroma)
Dimensions (W/H/D)	130 x 230 x 110 mm
Weight	app. 2 kg

### TO BE PROVIDED BY THE BUILDER

- Useful for rooms with a max. temperature of 50 °C
- Power socket 230 V-AC

### ACCESSORIES / OPTIONS

- Fragrance

## DUFTDOS-AK1-0

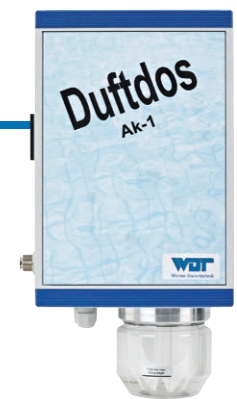

### FUNCTION DESCRIPTION

System for the aromatisation of Tepidariums, Caldariums, Infra-Red Saunas etc. without performance control, for cabinets with a room volume of app. 50 m<sup>3</sup>, depending on the air exchange rate. For the installation in the plants room. A small compressor blows air over the surface of a fragrance concentrate filled into a little bottle. The fragrance concentrate evaporates and is transported into the room by a tube 6 x 1 (max. 5 meter lenght). To be controlled externally by 230 V on/off control signal.

### SCOPE OF DELIVERY

- Compressor 7006 AC
- Bottle adapter
- PET-bottle 250 ml
- Filter star for the increase of the surface
- Housing with all components installed
- 5 m dosing tube PE 6 x 1
- Injection nozzle



### TECHNICAL DATA

Electrical supply	230 V-AC, 50 Hz
Power supply	app. 60 W
Evaporation performance max.	app. 5 ml of aroma in 24 h (depending on the aroma)
Dimensions (W/H/D)	250 x 500 x 130 mm
Weight	app. 4 kg
Noise emission in the plants room	app. 55 dB(A)

### TO BE PROVIDED BY THE BUILDER

- Useful for rooms with a max. temperature of 50 °C
- Control signal 230 V on/off (maximum on-time 25 %)

### ACCESSORIES / OPTIONS

- Fragrance





## DUFTDOS-AK1-NT35

### FUNCTION DESCRIPTION

System for the aromatisation of Tepidariums, Caldariums, Infra-Red Saunas etc. with performance control, for cabinets with a room volume of app. 50 m<sup>3</sup>, depending on the air exchange rate. For the installation in the plants room. Operation and visualisation via 5-line LC display and three buttons. A small compressor blows air over the surface of a fragrance concentrate filled into a little bottle. The fragrance concentrate evaporates and is transported into the room by a tube 6 x 1 (max. 5 m length). The aroma intensity is adjusted via pause- and dosing time at the controller. The aromatisation can optionally be started by a push button from within the cabinet or by a non-volt contact.

### SCOPE OF DELIVERY

- Controller NT35
- Compressor 7006 AC
- Bottle adapter
- PET-bottle 250 ml
- Filter star for the increase of the surface
- Housing with all components installed
- 5 m dosing tube PE 6 x 1
- Injection nozzle



### TECHNICAL DATA

Electrical supply	230 V-AC, 50 Hz
Power supply	app. 60 W
Evaporation	app. 5 ml of aroma in 24 h performance max. (depending on the aroma)
Dimensions (W/H/D)	210 x 320 x 120 mm
Weight	app. 2,75 kg
Noise emission in the plants room	app. 55 dB(A)

### TO BE PROVIDED BY THE BUILDER

- Useful for rooms with a max. temperature of 50 °C
- Power socket 230 V-AC

### ACCESSORIES / OPTIONS

- Fragrance
- Push button with bonnet for in-wall mounting
- Also available for 2 or 3 aromas (on demand)



Photo:  
DUFTDOS-AK2-NT35 for 2 aromas (option)

## DUFTDOS-AK4-T-EDS1

### FUNCTION DESCRIPTION

System for the aromatisation of Tepidariums, Caldariums, Infra-Red Saunas etc. with 4 different aromas. For cabinets with a room volume of app. 50 m<sup>3</sup>, depending on the air exchange rate. For the installation in the plants room. A small compressor blows air over the surface of a fragrance concentrate that is filled into a little bottle. The fragrance concentrate evaporates and is transported into the room by a tube 6 x 1 (max. 5 m length).

The demanded aroma is chosen by the user by a push-button. The aroma intensity can be set individually for each aroma at the controller. During the dosing of the demanded aroma the other aroma pumps are locked. After the lapse of the programme the dosing is blocked for 3 minutes.

### SCOPE OF DELIVERY

- Microprocessor controller EDS1 in housing
- 4 x Compressor 7006 AC
- 4 x Bottle adapter
- 4 x PET-bottle 250 ml
- 4 x Filter star for the increase of the surface
- Housing with all components installed
- 4 x 5 m dosing tube PE 6 x 1
- 4 x Injection nozzle



### TECHNICAL DATA

Electrical supply	230 V-AC, 50 Hz
Power supply	app. 60 W
Evaporation	app. 5 ml of aroma in 24 h performance max. (depending on the aroma)
Dimensions (W/H/D)	400 x 400 x 200 mm
Weight	app. 8 kg
Noise emission in the plants room	app. 55 dB(A)

### TO BE PROVIDED BY THE BUILDER

- Useful for rooms with a max. temperature of 50 °C
- Power socket 230 V-AC

### ACCESSORIES / OPTIONS

- Fragrance
- Push button with bonnet for in-wall mounting
- Also available for 2 or 3 aromas (on demand)





## CONTROL AND REGULATION SYSTEMS FOR WELLNESS AREAS

Only the harmony between water, aroma, steam, light, sound and heat makes wellness a pleasant and unique experience. These elements can be harmonized in an optimal way with our control systems.

We offer individual control and regulation systems that can be tailor-made for your wellness concept. The systems allow to control and operate all cabinets (saunas, steam rooms etc.), their components (sauna heaters, steam generators, fragrance dosings, illuminations etc.) and parameters (temperature, humidity etc.) of a whole SPA easily from one central display.

134 Central control systems for Wellness areas

135 Steam room controls

# TOUCH



## SMART WELLNESS CONTROL

- » Highest reliability due to the use of sophisticated industrial components
- » High grade of connectivity to all common building management systems (BMS) due to the use of ModBUS, KNX, BacNet etc. interfaces
- » Measured values, current operational status and alarms can be displayed with each browser driven device such as a PC, smartphone or tablet
- » Energy optimisation by intelligent software programming possible

**We consult you with pleasure about detailed configuration possibilities**





## CENTRAL CONTROL SYSTEMS FOR WELLNESS AREAS

### FUNCTION DESCRIPTION

Systems for the central control of all cabinets (saunas, steam rooms etc.), their components (sauna heaters, steam generators, fragrance dosing, illuminations etc.) and parameters (temperature, humidity etc.) of a Wellness area from one central display. The central control systems are planned and produced project-based. Therefore the systems can be adapted individually to the requirements of a project. For the operation and visualisation we use clearly designed and intuitively arranged touch screens from 4,3" to 10". They can be programmed in several languages. Furthermore measured values, current operational status and alarms can be displayed with each browser driven device such as a PC, smartphone or tablet.

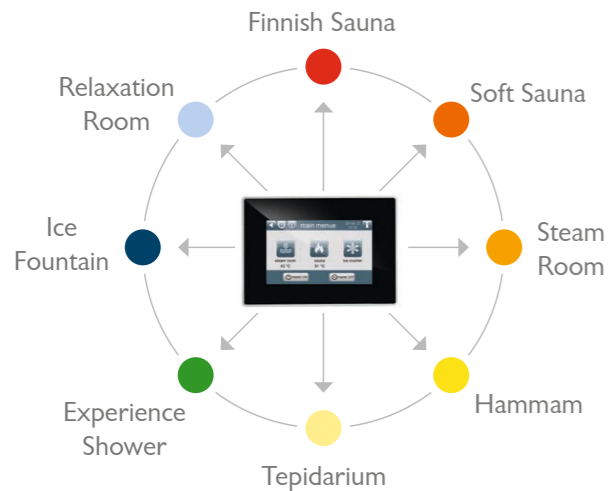

**The possible number of cabinets that can be controlled and the possibilities to combine them are nearly unlimited.**

### SCOPE OF DELIVERY (according to the configuration of the central control)

- SPS controller (Wago or Mitsubishi)
- Metal control cabinet (size according to the number of connected components)
- Temperature sensors PT1000 / humidity sensors / safety temperature limiters STL (quantity and characteristic according to the configuration of the control system)
- Touch Display: 4,3", 7" or 10" installed in control cabinet or for in-wall mounting
- As the case may be box for in-wall mounting of the Touch Display
- BUS cable for the connection controller - touch

### ACCESSORIES / OPTIONS

- Interfaces: ModBUS / KNX / BacNet etc.
- Module for the remote maintenance by WDT via Internet
- Touch Screens bigger than 10"



Touch Display, 4,3", 64000 colours

**The following exemplary specification describes a central control system for four cabinets:**

#### Finnish Sauna:

- Sauna heater - temperature controlled + STL
- Sauna splash system SAUNA-Plus
- Exhaust fan
- Illumination circuits (ceiling / under bench) - 230 V on/off - dimmable 0 - 10 V
- Connection door switch

#### Soft Sauna:

- Sauna heater – temperature controlled + STL
- Steam generator or steamer integrated in heater - humidity controlled
- Fragrance pump DUFTDOS-0
- Exhaust fan
- Illumination circuits (ceiling / under bench) - 230 V on/off - dimmable 0 - 10 V
- Connection door switch

#### Steam Room:

- Steam generator - temperature controlled
- Fragrance pump DUFTDOS-0
- Exhaust- and supply fan
- Illumination circuits (ceiling / under bench) - 230 V on/off - dimmable 0 - 10 V
- Bench heating 230 V on/off - temperature controlled
- Connection door switch

#### Hammam:

- Steam generator - humidity controlled
- Fragrance pump DUFTDOS-0
- Exhaust- and supply fan
- Illumination circuits - e.g. RGBW - dimmable 0 - 10 V
- Bench- and wall heating 230 V on/off - temperature controlled
- Connection door switch

## STEAM ROOM CONTROLS

### FUNCTION DESCRIPTION

Systems for the complete control of steam rooms, their components (steam generators, fragrance dosing, illuminations, exhaust- and supply fans etc.) and parameters (temperature, humidity etc.) from one touch screen display. The control systems are planned and produced project-based. Therefore the systems can be adapted individually to the special requirements of a project. With regards to the specification it is for example possible to operate a steam room in different operation modes (e.g. Classical Steam Room, Hammam, Tepidarium, Healing Clay Seam Bath, Salt Steam Room). For the operation and visualisation we use clearly designed and intuitively arranged touch screens from 3,8" to 7". They can be programmed in several languages. Furthermore measured values, current operational status and alarms can be displayed with each browser driven device such as a PC, smartphone or tablet.



Touch Display, 4,3", 64000 colours

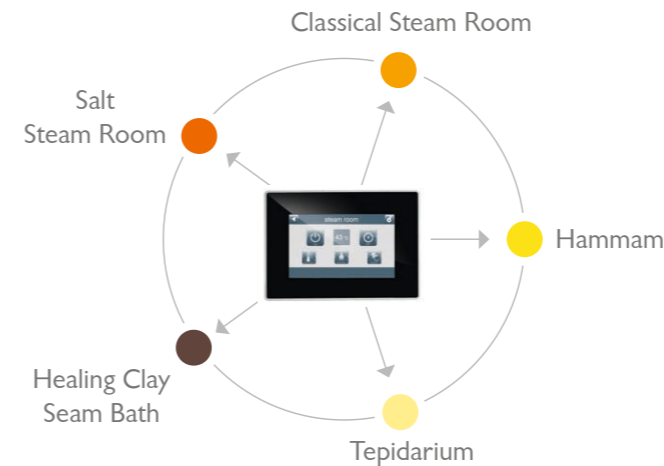

**The following exemplary specification describes a steam room control system with two operation modes (Classical Steam Room and Healing Clay Steam Bath):**

#### Controlled components:

- Steam generator - temperature controlled
- Fragrance pump DUFTDOS-0
- Exhaust fan
- Supply fan
- Illumination circuit ceiling - e.g. RGBW - dimmable 0 - 10 V
- Illumination circuit under bench - e.g. RGBW - dimmable 0 - 10 V
- Solenoid valve cleaning shower - 230 V on/off
- Bench heating 230 V on/off - temperature controlled
- Connection door switch
- MP3-player

### SCOPE OF DELIVERY

#### (according to the configuration)

- SPS controller (Wago or Mitsubishi) with 4 - 18 control outputs according to the number of connected components)
- Metal control cabinet (size according to the number of connected components)
- Temperature sensors PT1000 / humidity sensors (quantity and characteristic according to the configuration of the control system)
- Touch Display: 3,8", 4,3" or 7" installed in control cabinet or for in-wall mounting
- As the case may be box for in-wall mounting of the Touch Display
- BUS cable for the connection controller - touch

### ACCESSORIES / OPTIONS

- Interfaces: ModBUS / KNX / BacNet etc.
- Module for the remote maintenance by WDT via Internet
- Touch Screens bigger than 7"

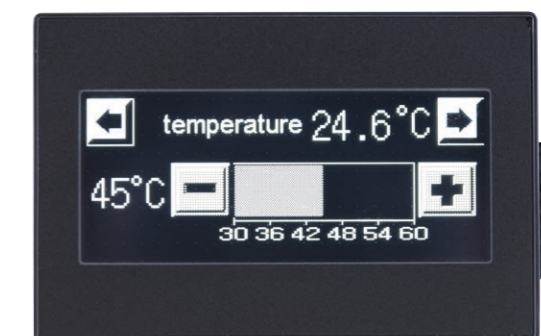

Touch Display, 3,8", 32 greyscales



## FRAGRANCES, BRINE SOLUTION, FOAM AGENT

Holistic concepts are the latest trend in wellness and spa facilities. All senses are activated in harmony at the same time (smell, sight, hearing and touch). The human perception of aroma is multisensual. This means that one sense is never perceived in isolation from the other senses. That's why warm water for example is associated with warm colours like red or yellow. The compatible aroma is fruity and strong. Therefore, it is important to have the right aromatisation technique and fragrance.

Depending on the application, a suitable carrier medium for the fragrance has to be used to aromatise a room. In steam rooms and experience showers, the fragrance is injected directly in the steam- or water tube. In the sauna, fragrance is mixed with water and splashed onto the hot stones. The fragrances that we offer are mixtures of natural and nature identical etheric oils and aromas. To make them dissolvable in water we use solutisers that are also used in the food and cosmetic industry. For each fragrance we provide a corresponding material safety data sheet.

Brine solution is used to create a salty sea climate for wellness applications. Our brine solution is delivered sterile in special air sealed bags (Poltainers) with an expiry date. The product line is rounded off by pleasant smelling foam agents for Hammam massages. The available scents are rose and hayflower.



Here a small choice of our fragrances - others on demand:

	Fragrances for Steam Rooms	Fragrances for Sauna	Fragrances for Experience Showers	Fragrances for Room Aromatisation
<b>Exotic</b>				
Orange				•
Orange-Tangerine	•	•		
Lemon				•
Papaya				•
Ceylon Mango	•			
Passion Fruit				•
Tropica/Passion Fruit			•	
Ice Lime	•			
Exotic Dream				•
Apple		•		
Bourbon Vanille	•	•		•
Mexico Lemon Grass	•			•
Lime		•		
Sumatra Orange			•	
<b>Floral</b>				
West-Indian-Rose	•	•		
Provence Lavender	•	•		
Sommer Grassland				•
<b>Minty</b>				
Alaska Mint	•	•		
Euka-Mint				•
Eucalyptus Menthole	•	•		
Ice-Mint/Arctic Sea			•	
Polaric Night			•	
<b>Green</b>				
Noble Fir/Spruce Needle	•	•		
Mountain Pine	•	•		
Eucalyptus				•
China Eucalyptus	•	•		
Finnish Birch tree			•	
Siberian Ice Steppe			•	
<b>Aromatic</b>				
Herbs of the Alps	•	•		•
French Melissa	•	•		
Camomile	•			•
Oriental	•			•
Toscana Herbal Garden	•			
<b>Woody</b>				
Sandle Wood				•





## FRAGRANCES FOR STEAM ROOMS

Fragrances for steam rooms, deliverable in 1 l - 3 l - 5 l - 10 l canisters.



## FRAGRANCES FOR SAUNA

Fragrances for saunas, deliverable in 1 l - 3 l - 5 l - 10 l canisters.



## FRAGRANCES FOR EXPERIENCE SHOWERS

Fragrances for showers, deliverable in 1 l - 3 l - 5 l - 10 l canisters.

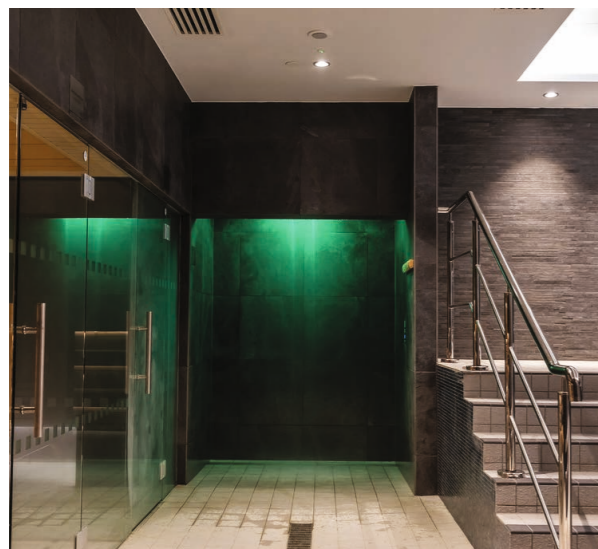

## FRAGRANCES FOR ROOM AROMATISATION

Fragrances for room aromatisation, deliverable in 1 l bottles or 50 ml refill pack.



## BRINE SOLUTION

Sterile, 5 % brine solution for the nebulisation with SOLDOS/SOLFOG to create a salty sea climate in the room.

Filled in Politainers (air sealed bag) to prevent the contamination of the brine solution with germs of the ambient air.

### SCOPE OF DELIVERY

6 pieces of "Politainers" filled with 5 % brine solution, packed in carton.

Part no.	Description
17669	6 x 1 l brine solution incl. disinfection tabs
17667	6 x 5 l brine solution incl. disinfection tabs

## FOAM AGENT

Foam agent for Hammam massages with FOAMDOS.

### SCOPE OF DELIVERY

Part No.	Description
15455	Foam agent - <b>Rose</b> 10 l pH-neutral for sensitive skin with rose and coco oil
18347	Foam agent - <b>Hey Flower</b> 10 l pH-neutral for sensitive skin

### Photos with the kind support of:

© Gregor Eisele - Kaloo Images

© Eckhart Matthäus - Heli Works

Alpha Industries AWT BVBA

Anton Mütter GmbH

Aqua Sana Sherwood Forest

Barr + Wray Limited

BEYER S.A.S

Bossini SPA

Eberl GmbH

Elite Hotel Karlstad

EOS Premium Spa Technology

Fliesenverlegebetrieb Wolfgang Peters

Hotel die Post Meerfeld

Hôtel-Restaurant Julien

Hotel Riedl

Hotel Söderköpings Brunn

Kakelspecialisten AB

La Source des Sens

Pennyhill Park Hotel

Ponteland Tranquility Spa

PROMET A.S.

Rudding Park Hotel

Sauna360 Ltd

Sauna Technika Kft

Slottsholmen, Warmbadhuset

Sommerhuber GmbH





**Werner Dosiertechnik**

The better solution.

**WDT Werner Dosiertechnik GmbH & Co. KG**

Hettlinger Straße 17  
D-86637 Wertingen  
Tel. +49 (0) 8272 98697-0  
Fax +49 (0) 8272 98697-19  
info@werner-dosierttechnik.de  
www.werner-dosierttechnik.de



## ASSOCIATIONS



Member of  
**German Water  
Partnership**



**Deutsche Gesellschaft  
für das Badewesen e.V.**



**BUNDESVERBAND  
SCHWIMMBAD  
& WELLNESS E.V.**



**IAKS**   
International Association  
for Sports and Leisure Facilities



Das Herstellernetzwerk  
für den professionellen Schwimmbadbau



ÖSTERREICHISCHES  
SAUNA  
FORUM



www.hydrothermal-spa-forum.com